

# Agricultural Tyres

## Technical Databook

Edition 2018/2019



[mitas-tyres.com](http://mitas-tyres.com)

**Mitas**



## **Mitas Technical Databook for Agricultural Tyres – World edition 2018 /2019**

The extensive technical data and other information relating to tyres and accessories on the following pages has been compiled to reflect as accurately and completely as possible the current state of development. Due to changes in our product range the tyre sizes given in this guide are not always identical to our available range.

Mitas, part of the Trelleborg Group, is one of Europe's leading producers of tyres for agricultural machines, construction vehicles, motorcycles, bicycles and other specialty segments. Mitas has manufacturing facilities in the Czech Republic, Serbia, Slovenia, U.S. and a global sales and distribution network.

For further information please contact us:

### **MITAS a.s.**

Švehlova 1900/3, 106 00 Prague 10, Czech Republic

# Contents

## Tread patterns, markings and definitions

List of tread patterns	4
List of tyre sizes	6
Tyre size marking	10
Speed symbols and conversion tables	11
Tyre sidewall marking and structures	12
Load index	13
Main applications chart	14

### Tractor Radial Tyres

<b>NEW!</b> VF – Very high capacity tyre HC 1000, HC 2000	16
SFT – Super Flexion Tyre	22
SST – Silent Speed Tyre	34
AC 65 – 65 series	38
HC 70 – 70 series	46
AC 70 T – 70 series	52
AC 70 G – 70 series	60
AC 85 – standard	64
AC 85 / AC 90 – Row Crop	74

### Harvester Radial Tyres

<b>NEW!</b> CFO – High Capacity (HC) – drive wheel – VF series	84
CHO – drive wheel	88
SFT and AC 70 H/G/N – drive wheel	94
SFT, AC 70 G, AC 65 IMP – steering wheel	104
Conversion table – tractor and harvester radial tyres	110

### Trailer Radial Tyres

<b>NEW!</b> Agriterra 02 and 03	114
AR – Agricultural radial	120

### Municipal, Agro-industrial and Multipurpose Tyres

<b>NEW!</b> High Capacity Municipal radial (HCM)	126
Agro-industrial radial	130
Multipurpose radial (MPT)	134
Agro-industrial diagonal	142

### Tractor Diagonal Tyres

AF – Tractor Agro Forestry	152
TD – Tractor Drive (diagonal)	156

### Implement Diagonal Tyres

IM – Implement Non Traction	168
TR – Implement Traction	178

### Other Tyres

TS – Tractor Small	186
TF – Tractor Front	194
B – Bantam	204

## Use and Maintenance

U.S. Tread pattern marking	206
Use and Maintenance	207
Fitting and removal instructions	208
Liquid ballasting of tractor tyres	209
Explanations referring to tractor tyres	214
Explanations referring to IMP/MPT tyres	216
Rim specification	218
Terms and abbreviations used in this catalogue	222

Tread patterns

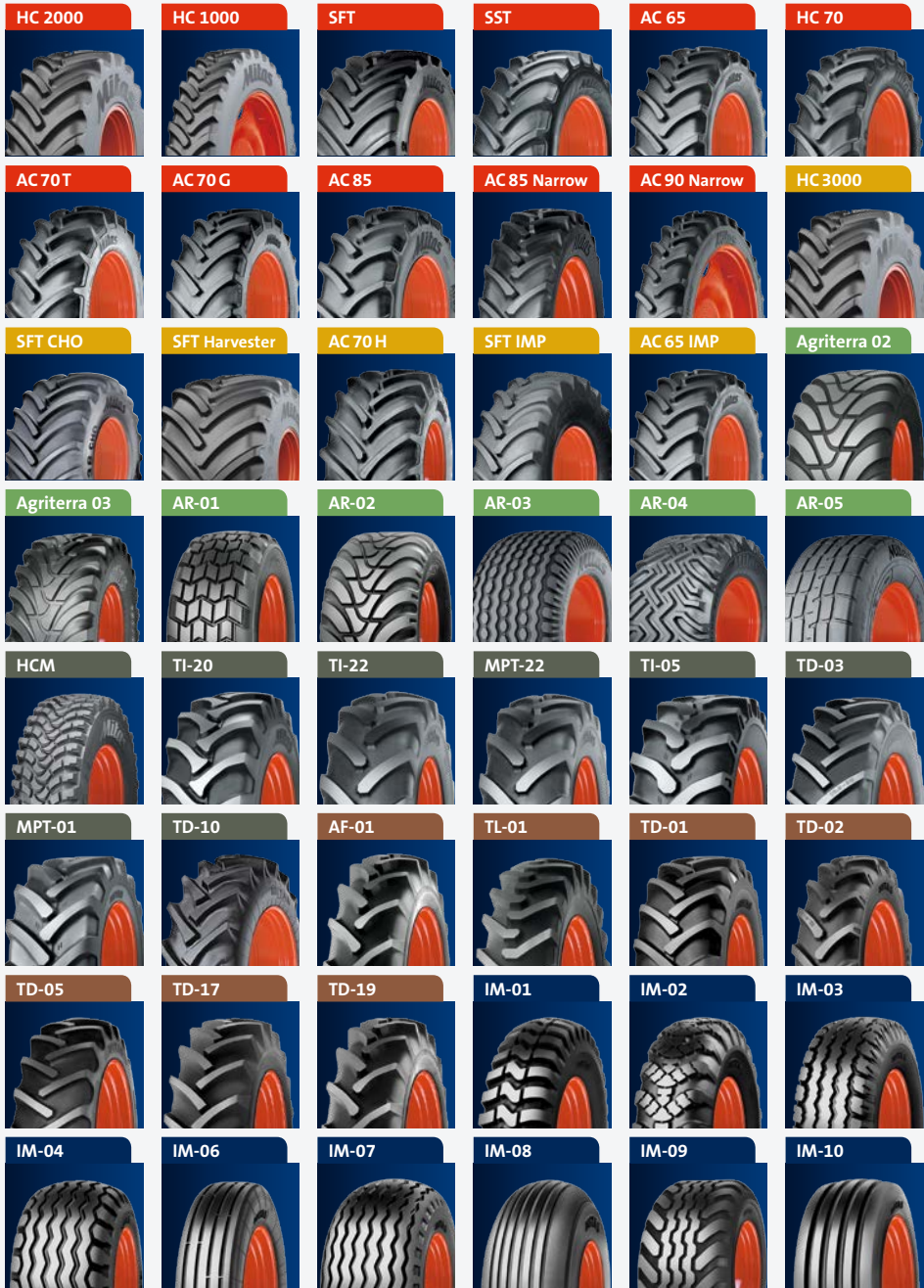

Tractor Radial Tyres

Page 16

Trailer Radial Tyres

Page 114

Harvester Radial Tyres

Page 84

Agro-industrial Tyres

Page 126



Tractor Diagonal Tyres  
Diagonal Tyres

Page 152  
Page 168

# List of tyre sizes

Size (inch)	Tyre size (Alternative tyre size)	Tread pattern	Page
<b>Tractor Radial and Harvester Radial</b>			
<b>16"</b>	200/70 R 16	AC 70 T	54
	240/70 R 16	AC 70 T	54
	260/70 R 16	AC 70 T	54
	280/70 R 16	AC 70 T	54
	320/65 R 16	AC 65	40
<b>18"</b>	280/70 R 18	AC 70 T	54
<b>20"</b>	260/70 R 20	AC 70 T	54
	280/70 R 20	AC 70 T	54
	280/85 R 20 (11.2 R 20)	AC 85	66
	300/70 R 20	AC 70 T	54
	320/70 R 20	AC 70 T	54
	360/70 R 20	AC 70 T	54
	380/70 R 20	AC 70 T	56
	420/65 R 20	AC 65	40
<b>24"</b>	280/85 R 24 (11.2 R 24)	AC 85	66
	320/70 R 24	HC 70	48
	320/70 R 24	AC 70 T	56
	320/85 R 24 (12.4 R 24)	AC 85	66
	340/85 R 24 (13.6 R 24)	AC 85	66
	360/70 R 24	HC 70	48
	360/70 R 24	AC 70 T	56
	380/70 R 24	HC 70	48
	380/70 R 24	AC 70 T	56
	380/70 R 24	AC 70 G	62
	380/85 R 24 (14.9 R 24)	AC 85	66
	420/70 R 24	HC 70	48
	420/70 R 24	AC 70 T	56
	420/70 R 24	AC 70 G	62
	420/85 R 24 (16.9 R 24)	AC 85	66
	440/65 R 24	AC 65	40
	460/70 R 24 IMP	AC 70 G	106
	480/65 R 24	AC 65	40
	480/70 R 24	HC 70	48
	480/70 R 24	AC 70 G	62
	500/70 R 24 IMP	AC 70 G	106
	500/85 R 24 IMP	SFT	106
	540/65 R 24	AC 65	40
<b>25"</b>	1000/50 R 25	SFT	24, 96
<b>26"</b>	620/75 R 26	SFT	24, 96
	750/65 R 26	SFT	24
<b>28"</b>	280/85 R 28 (11.2 R 28)	AC 85	66
	320/85 R 28 (12.4 R 28)	AC 85	66
	340/85 R 28 (13.6 R 28)	AC 85	66
	380/70 R 28	HC 70	48
	380/70 R 28	AC 70 T	56
	380/85 R 28 (14.9 R 28)	AC 85	66
	420/70 R 28	HC 70	48
	420/70 R 28	AC 70 T	56
	420/70 R 28	AC 70 G	62
	VF 420/85 R 28 (16.9 R 28)	HC 2000	18
	420/85 R 28 (16.9 R 28)	AC 85	68
	440/65 R 28	AC 65	40

Size (inch)	Tyre size (Alternative tyre size)	Tread pattern	Page
	480/65 R 28	AC 65	42
	480/70 R 28	HC 70	48
	480/70 R 28	AC 70 T	56
	500/80 R 28 IMP	SFT	106
	540/65 R 28	SFT	24
	540/65 R 28	AC 65	42
	600/65 R 28	SFT	24
	600/65 R 28	AC 65	42
	600/65 R 28 IMP	AC 65	108
	600/70 R 28	SFT	24
<b>30"</b>	380/85 R 30 (14.9 R 30)	AC 85	68
	420/70 R 30	HC 70	48
	420/70 R 30	AC 70 T	56
	420/85 R 30 (16.9 R 30)	AC 85	68
	420/90 R 30	AC 85	68
	460/85 R 30 (18.4 R 30)	AC 85	68
	480/70 R 30	HC 70	50
	480/70 R 30	AC 70 T	56
	480/70 R 30	AC 70 G	62
	500/85 R 30 IMP	SFT	106
	VF 540/65 R 30	HC 2000	18
	540/65 R 30	SFT	26
	540/65 R 30	AC 65	42
	540/65 R 30 IMP	AC 65	108
	600/65 R 30	AC 65	42
	VF 600/70 R 30	HC 2000	18
	600/70 R 30	SFT	26
	620/70 R 30 IMP	SFT	106
	620/70 R 30 IMP	SFT N	108
	620/75 R 30	SFT	26
	620/75 R 30 IMP	SFT	106
	710/55 R 30	SFT	26
	710/60 R 30	SFT	26
	710/60 R 30 IMP	SFT	106
	710/65 R 30 IMP	SFT	106
	750/55 R 30	SFT	26
<b>32"</b>	270/80 R 32	AC 90	76
	270/95 R 32	AC 85	76
	320/85 R 32 (12.4 R 32)	AC 85	76
	320/90 R 32	AC 85	76
	650/75 R 32	AC 70 H	96
	IF 650/75 R 32	AC 75 G	96
	650/75 R 32	AC 75 G	96
	650/75 R 32	AC 70 G	98
	680/85 R 32 CHO	AC 70 G	90
	680/85 R 32	AC 70 G	98
	800/65 R 32	AC 70 H	98
	800/65 R 32	AC 70 N	98
	800/70 R 32 CHO	SFT	90
	800/70 R 32	SFT	26, 100
	900/60 R 32 CHO	SFT	90
	900/60 R 32	SFT	26, 100
	900/70 R 32 CHO	SFT	90

Size (inch)	Tyre size (Alternative tyre size)	Tread pattern	Page
	900/70 R 32	SFT	28,100
	1050/50 R 32	SFT	28,100
	1250/50 R 32	SFT	28,100
<b>34"</b>	320/85 R 34	AC 85	76
	VF 380/85 R 34 (14.9 R 34)	HC 2000	18
	380/85 R 34 (14.9 R 34)	AC 85	68
	VF 420/85 R 34 (16.9 R 34)	HC 2000	18
	420/85 R 34 (16.9 R 34)	AC 85	68
	460/85 R 34 (18.4 R 34)	AC 85	68
	480/70 R 34	HC 70	50
	480/70 R 34	AC 70 T	58
	480/70 R 34	AC 70 G	62
	500/85 R 34 IMP	SFT	108
	520/70 R 34	HC 70	50
	520/70 R 34	AC 70 T	58
	520/70 R 34	AC 70 G	62
	540/65 R 34	AC 65	42
	VF 580/80 R 34 CFO	HC 3000	86
	600/65 R 34	AC 65	42
	650/60 R 34	SFT	28
	650/65 R 34	SFT	28
	710/60 R 34	SFT	28
<b>36"</b>	270/80 R 36	AC 90	76
	13.6 R 36	AC 90	76
<b>38"</b>	320/85 R 38 (12.4 R 38)	AC 85	78
	340/85 R 38 (13.6 R 38)	AC 85	68, 78
	15.5 R 38	AC 51	70
	380/80 R 38 (14.9 R 38)	AC 85	70
	VF 380/95 R 38	HC 2000	18
	380/95 R 38	AC 85	70
	420/85 R 38 (16.9 R 38)	AC 85	70
	460/85 R 38 (18.4 R 38)	AC 85	70
	480/70 R 38	HC 70	50
	480/70 R 38	AC 70 T	58
	520/70 R 38	HC 70	50
	520/70 R 38	AC 70 T	58
	520/70 R 38	AC 70 G	62
	520/85 R 38 (20.8 R 38)	AC 85	70
	540/65 R 38	AC 65	42
	580/70 R 38	HC 70	50
	580/70 R 38	AC 70 T	58
	600/65 R 38	SST	36
	600/65 R 38	AC 65	44
	650/65 R 38	SFT	30
	650/65 R 38	SST	36
	650/65 R 38	AC 65	44
	650/75 R 38	SFT	30
	650/85 R 38	SFT	30
	680/80 R 38 CHO	SFT	90
	710/70 R 38	SFT	30
	710/70 R 38	AC 65	44
	800/70 R 38 CHO	SFT	90
	800/70 R 38	SFT	30

Size (inch)	Tyre size (Alternative tyre size)	Tread pattern	Page
	900/60 R 38 CHO	SFT	92
	900/60 R 38	SFT	30,102
<b>42"</b>	300/85 R 42 (11.2 R 42)	AC 90	78
	300/95 R 42 (12.4 R 42)	AC 90	78
	IF 320/90 R 42	AC 85	78
	320/90 R 42	AC 85	78
	480/80 R 42	AC 85	70
	VF 520/85 R 42 (20.8 R 42)	HC 2000	18
	VF 520/85 R 42 CFO (20.8 R 42)	HC 3000	86
	520/85 R 42 (20.8 R 42)	AC 85	70
	VF 580/85 R 42 CFO	HC 3000	86
	580/85 R 42	SFT	32,102
	VF 650/65 R 42	HC 2000	18
	650/65 R 42	SST	36
	650/65 R 42	AC 65	44
	650/75 R 42	SFT	32
	680/80 R 42 CHO	SFT	92
	680/80 R 42	SFT	32,102
	VF 710/70 R 42	HC 2000	18
	VF 710/70 R 42 CFO	HC 3000	86
	710/70 R 42	SFT	32
	710/75 R 42	SFT	32
	800/70 R 42 CHO	SFT	92
	900/60 R 42	SFT	32
	900/60 R 42 CHO	SFT	92
<b>46"</b>	320/95 R 46	AC 85	78
	VF 380/90 R 46	HC 1000	20
	380/90 R 46	AC 85	78
	VF 480/80 R 46	HC 2000	18
	480/80 R 46	AC 85	70
	520/85 R 46 (20.8 R 46)	AC 85	70
	710/65 R 46	SFT	32
	IF 710/65 R 46	SFT	32
<b>48"</b>	270/95 R 48	AC 90	80
	340/90 R 48 (13.6 R 48)	AC 85	80
<b>50"</b>	320/90 R 50	AC 85	80
	380/90 R 50	AC 85	72, 80
	VF 380/105 R 50	HC 1000	20
	VF 480/80 R 50	HC 1000	20
	480/80 R 50	AC 85	72
	VF 480/95 R 50	HC 2000	18
	480/95 R 50	AC 85	72
<b>54"</b>	320/90 R 54	AC 85	80
	VF 320/105 R 54	HC 1000	20
	380/90 R 54	AC 85	80
	VF 380/105 R 54	HC 2000	18
	380/105 R 54	AC 85	82

# List of tyre sizes (continued)

Size (inch)	Tyre size (Alternative tyre size)	Tread pattern	Page
<b>Trailer Radial</b>			
17"	440/50 R 17 IMP	AR-04	124
	500/50 R 17 IMP	AR-03	124
18"	335/60 R 18 MPT	AR-05	124
22.5"	385/65 R 22.5 (15 R 22.5)	AR-01	122
	445/65 R 22.5 (18 R 22.5)	AR-01	122
	460/65 R 22.5 IMP	AR-01	122
	500/60 R 22.5 IMP	Agriterra 02	116
	560/45 R 22.5 IMP	Agriterra 02	116
	560/60 R 22.5 IMP	Agriterra 02	116
	560/60 R 22.5 IMP	AR-02	124
	600/50 R 22.5 IMP	Agriterra 02	116
	710/45 R 22.5 IMP	Agriterra 02	116
26.5"	600/55 R 26.5 IMP	Agriterra 02	116
	650/55 R 26.5 IMP	Agriterra 02	116
	650/65 R 26.5 IMP	Agriterra 02	118
	710/50 R 26.5 IMP	Agriterra 02	118
	800/45 R 26.5 IMP	Agriterra 03	118
30.5"	680/60 R 30.5 IMP	Agriterra 03	118
	750/60 R 30.5 IMP	Agriterra 02	118
	850/50 R 30.5 IMP	Agriterra 02	118
<b>Municipal, Agro-industrial Radial</b>			
18"	340/80 R 18 IND	TI-20	132
24"	400/80 R 24 IND	HCM	128
	440/80 R 24 IND	HCM	128
	460/70 R 24 IND (17.5L R 24)	TI-22	132
26"	480/80 R 26 IND	TI-20	132
28"	400/80 R 28 IND	HCM	128
	440/70 R 28 IND	AC 70 G	132
	440/80 R 28 IND	HCM	128
	440/80 R 28 IND	TI-20	132
34"	480/80 R 34 IND	HCM	128
38"	480/80 R 38 IND	HCM	128
	540/80 R 38 IND	HCM	128
<b>Multipurpose Radial</b>			
16"	265/70 R 16 MPT	AC 70 G	136
	285/80 R 16 MPT	AC 70 G	136
17"	425/55 R 17 MPT	AC 70 G	136
18"	325/70 R 18 MPT	AC 70 G	136
	365/70 R 18 MPT	AC 70 G	136
20"	275/80 R 20 MPT	AC 70 G	136
	335/80 R 20 MPT	AC 70 G	136
	375/70 R 20 MPT	AC 70 G	138
	405/70 R 20 MPT	AC 70 G	138
	425/75 R 20 MPT	AC 70 G	138
22.5"	445/65 R 22.5 MPT	AC 70 +	138
24"	405/70 R 24 MPT	AC 70 G	138
	445/70 R 24 MPT	AC 70 G	138
	445/70 R 24 MPT (17.5L R 24)	MPT-22	138
	495/70 R 24 MPT	AC 70 G	140
30"	495/70 R 30 MPT	AC 70 G	140
<b>Agro-industrial Diagonal</b>			
18"	280/80-18 MPT (10.5-18)	MPT-01	144
	275/80-18 MPT (10.5-18)	TD-10	144
	320/80-18	TD-10	150
20"	340/80-18 MPT (12.5-18)	MPT-01	144
	275/80-20 MPT	TD-10	144
	335/80-20 MPT	TD-10	144
	340/80-20 MPT (12.5-20)	MPT-01	144
	360/80-20	TD-10	150
	365/80-20 MPT	TD-10	144
	400/70-20	TD-10	150

Size (inch)	Tyre size (Alternative tyre size)	Tread pattern	Page
	400/70-20	TR-01	146
24"	405/70-20 MPT (16/70-20)	MPT-01	146
	15.5/80-24	TR-01	146
	15.5/80-24	TD-10	150
	400/80-24 IND (15.5/80-24)	TI-05	148
	405/70-24 MPT (16/70-24)	MPT-01	146
	16.5/85-24	TD-10	150
	17.5L-24	TR-01	146
	460/70-24 IND	TI-05	148
	460/70-24 IND (17.5L-24)	TR-01	148
	19.5L-24 IND	TI-05	148
	500/70-24 IND (19.5L-24)	TI-05	148
30"	16.9-30 IND	TD-03	148
<b>Tractor Agro Forestry</b>			
24"	380/85-24 (14.9-24)	AF-01	154
28"	380/85-28 (14.9-28)	AF-01	154
30"	16.9-30	TL-01	154
34"	420/85-34 (16.9-34)	AF-01	154
	460/85-34 (18.4-34)	AF-01	154
<b>Tractor Diagonal</b>			
20"	8.3-20	TD-13	158
24"	8.3-24	TD-02	158
	9.5-24	TD-02	158
	11.2-24	TD-02	158
	11.2-24	TD-10	158
	11.2-24	TD-19	158
	12.4-24	TD-02	158
	12.4-24	TD-19	158
	13.6-24	TD-19	158
	14.9-24	TD-02	158
	14.9-24	TD-19	160
	16.9-24	TD-02	160
	16.9-24	TD-13	160
26"	18.4-26	TD-19	160
	23.1-26	TD-01	160
28"	11.2-28	TD-02	160
	12.4-28	TD-19	160
	12.4-28	TD-02	160
	13.6-28	TD-19	160
	14.9-28	TD-19	162
	16.9-28	TD-02	162
	16.9-28	TD-13	162
30"	16.9-30	TD-13	162
	16.9-30	TD-17	162
	18.4-30	TD-13	162
32"	9.5-32	TD-13	162
	12.4-32	TD-13	162
34"	16.9-34	TD-02	162
	16.9-34	TD-17	164
	18.4-34	TD-19	164
	18.4-34	TD-02	164
36"	12.4-36	TD-13	164
	13.6-36	TD-13	164
38"	12.4-38	TD-17	164
	13.6-38	TD-02	164
	13.6-38	TD-13	164
	14.9-38	TD-05	166
	15.5-38	TD-05	166
	16.9-38	TD-19	166
	16.9-38	TD-13	166
	18.4-38	TD-19	166



Size (inch)	Tyre size (Alternative tyre size)	Tread pattern	Page
<b>Implement Diagonal</b>			
6"	13×5.00-6	G 1	170
	13×5.00-6	B 19	170
8"	15×6.00-6	B 19	170
	16×6.50-8	B 19	170
	18×8.50-8	G 1	170
10"	18.5×8.50-8	B 63	170
	4.00-10	IM-06	170
12"	7.00-12	IM-11	170
	10.0/80-12	IM-04	170
14.5"	10.0/80-12	IM-08	170
	200/60-14.5	IM-10	172
15"	240/70-15	B 3	172
	28×9.00-15	AC30	172
	31×15.50-15	TR-06	180
15.3"	31×15.50-15	TR-07	180
	10.0/75-15.3	IM-04	172
	10.0/75-15.3	TR-03	180
16"	10.0/75-15.3	TR-04	180
	11.5/80-15.3	IM-04	172
	11.5/80-15.3	TR-03	180
15.5"	12.5/80-15.3	IM-04	172
	400/60-15.5	IM-07	174
	400/60-15.5	TR-08	180
17"	10.50-16	IM-01	174
	15.0/55-17	IM-04	174
17.5"	15.0/55-17	TR-01	182
	19.0/45-17	IM-04	174
	480/45-17	TR-01	182
18"	500/50-17	IM-07	174
	14-17.5	TR-10	182
18.5"	12.0/75-18	TR-03	182
	12.0/75-18	TR-11	182
	12.5/80-18	IM-03	174
20"	12.5/80-18	IM-04	176
	13.0/65-18	IM-04	176
	360/95-18	IM-02	176
20.5"	14.5/80-18	IM-03	176
	14.5/80-18	TR-05	182
	500/45-20	TR-12	182
22.5"	500/60-22.5	TR-08	184
	500/60-22.5	IM-09	176
	500/60-22.5	TR-12	184
23"	550/60-22.5	IM-09	176
	550/60-22.5	TR-08	184
	600/40-22.5	TR-12	184
24"	600/50-22.5	TR-08	184
	<b>Tractor Small</b>		
	6"	3.50-6	B 16
13×5.00-6		B 12	188
8"	3.50-8	B 16	188
	4.00-8	TS-01	188
10"	4.00-8	B 12	188
	16×6.50-8	B 64	188
	4.00-10	B 12	188
12"	4.0-10	TS-03	188
	4.0-10	B 17	188
	5.0-10	B 16	188
14"	5.0-10	TS-03	188
	5.0-10	B 17	188
	4.00-12	B 12	188
16"	5.00-12	TS-02	188

Size (inch)	Tyre size (Alternative tyre size)	Tread pattern	Page
14"	5.00-12	B 12	188
	6.5/90-12 (170/90-12)	TS-06	190
15"	6.5/80-12	B 18	190
	11.0/65-12	TD-10	190
15.3"	6.5/75-14	TS-02	190
	5.00-15	TS-06	190
16"	6.5/90-15 (170/90-15)	TS-06	190
	690×180-15	TS-07	190
	10.0/75-15.3	TS-05	190
17"	11.5/80-15.3	TS-05	192
	6.00-16	TS-04	192
	6.00-16	TD-13	192
18"	6.50-16	TD-10	192
	7.50-16	TS-04	192
	7.50-16	TD-13	192
20"	7.50-20	TS-04	192
	7.50-20	TD-13	192
	8.3-20	TD-13	192
<b>Tractor Front</b>			
16"	4.00-16	TF-02	196
	4.50-16	TF-02	196
17"	5.00-16	TF-02	196
	6.00-16	TF-01	196
	6.00-16	TF-02	196
18"	6.00-16	TF-03	196
	6.00-16	TF-06	196
	6.50-16	TF-02	196
19"	6.50-16	TF-03	198
	6.50-16	TF-05	198
	7.50-16	TF-01	198
20"	7.50-16	TF-01	198
	7.50-16	TF-03	198
	7.50-16	TF-05	198
21"	9.00-16	TF-03	198
	10.00-16	TF-03	200
	11.1-16	IM-05	200
18"	6.00-18	TF-03	200
	6.00-18	TF-04	200
20"	6.50-20	TF-03	200
	6.50-20	TF-04	200
	6.50-20	TF-05	200
22"	7.50-20	TF-01	200
	7.50-20	TF-03	200
	7.50-20	TF-05	202
<b>Bantam</b>			
6"	3.50-6	B 15	205
	3.50-6	B 15 Ribbed	205
8"	4.00-6	V-5501	205
	4.00-6	B 11	205
	16×4	B2	205
10"	16×4	B5	205
	3.50-8	B6	205
	3.50-8	V-5501	205
12"	3.50-8	B 11	205
	3.50-8	B 15	205
	4.00-8	V-5501B	205
14"	4.00-8	V-5501A	205
	4.00-8	B 11	205

## Tyre size marking

340/85 R 24	
340	Nominal section width (in mm)
85	Aspect ratio H/SW (in %)
R	Radial construction
24	Nominal rim diameter (in inches)

15.0/55 – 17	
15.0	Nominal section width (in inches)
55	Aspect ratio H/SW (in %)
-	Cross-ply construction
17	Nominal rim diameter (in inches)

31 × 15.50 – 15	
31	Overall diameter (in inches)
15.50	Nominal section width (in inches)
-	Cross-ply construction
15	Nominal rim diameter (in inches)

17.5 L – 24	
17.5	Nominal section width (in inches)
L	Reduced aspect ratio
-	Cross-ply construction
24	Nominal rim diameter (in inches)

7.50 – 20	
7.50	Nominal section width (in inches)
-	Cross-ply construction
20	Nominal rim diameter (in inches)

16 × 4	
16	Overall diameter (in inches)
4	Nominal section width (in inches)

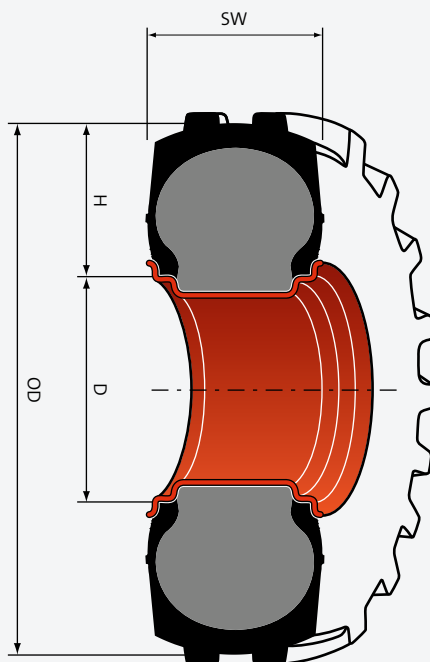

SW Section width  
 OD Overall diameter  
 H Section height  
 D Rim diameter

# Speed symbols and conversion tables

## Speed category

Speed symbol	A1	A2	A3	A4	A5	A6	A7	A8	B	D	F	G	J	K
Speed (km/h)	5	10	15	20	25	30	35	40	50	65	80	90	100	110

## Pressure units conversion table

bar	1.0	1.5	2.0	2.5	3.0	3.5	4.0	4.5	5.0	5.5
kPa	100	150	200	250	300	350	400	450	500	550
p. s. i.	15	22	29	36	44	51	58	65	73	80

bar	6.0	6.5	7.0	7.5	8.0	8.5	9.0	9.5	10.0	10.5
kPa	600	650	700	750	800	850	900	950	1 000	1 050
p. s. i.	87	94	102	109	116	123	131	138	145	152

## Units conversion table

Length	Mass	Pressure
1 millimeter (mm) = 0.03937"	1 pound (lb) = 0.4536 kg	1 p. s. i. (lb/in <sup>2</sup> ) = 6.895 kPa
1 inch (") = 25.4 mm = 0.0254 m	1 kilogram (kg) = 2.205 lb	1 kg/cm <sup>2</sup> = 98.066 kPa
1 meter (m) = 3.281 ft		1 bar = 100 kPa
1 foot (ft) = 0.3048 m	Volume	
1 kilometer (km) = 0.6214 mile	1 litre (l) = 0.21 gall	
1 mile = 1609 m = 1.609 km	1 imperial gallon (imp.gal) = 4.55 l	







## Tyre sidewall marking

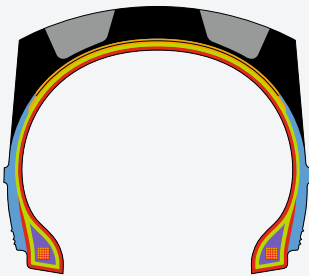

Sign	Meaning
<b>MITAS</b>	Trademark of producer
<b>480/70 R 34</b>	Tyre size marking
<b>HC 70</b>	Tread pattern code
<b>146</b>	Load index (LI 146 = 3 000 kg)
<b>A8</b>	Speed symbol (A8 = 40 km/h)
<b>143</b>	Load index (LI 143 = 2 725 kg)
<b>D</b>	Speed symbol (D = 65 km/h)
<b>TUBELESS</b>	Tubeless tyre
	Direction of rotation
<b>R-1W</b>	US tread profile marking

## Tyre structure



-  Tread Pattern
-  Breaker Cord
-  Inner Liner
-  Carcass Cord
-  Sidewall
-  Apex
-  Bead Wire



### BIAS (DIAGONAL, CROSS-PLY) TYRE

A pneumatic tyre in which the ply cords extend to the beads and are laid substantially at alternate angles less than 90° to the centre-line of the tread.



### RADIAL PLY TYRE

A pneumatic tyre in which the ply cords extend to the beads and are laid substantially at 90° to the centre-line of the tread, the carcass being stabilised by an essentially inextensible circumferential belt.

# Load index

LI	kg	LI	kg	LI	kg	LI	kg	LI	kg
30	106	65	290	100	800	135	2 180	170	6 000
31	109	66	300	101	825	136	2 240	171	6 150
32	112	67	307	102	850	137	2 300	172	6 300
33	115	68	315	103	875	138	2 360	173	6 500
34	118	69	325	104	900	139	2 430	174	6 700
35	121	70	335	105	925	140	2 500	175	6 900
36	125	71	345	106	950	141	2 575	176	7 100
37	128	72	355	107	975	142	2 650	177	7 300
38	132	73	365	108	1 000	143	2 725	178	7 500
39	136	74	375	109	1 030	144	2 800	179	7 750
40	140	75	387	110	1 060	145	2 900	180	8 000
41	145	76	400	111	1 090	146	3 000	181	8 250
42	150	77	412	112	1 120	147	3 075	182	8 500
43	155	78	425	113	1 150	148	3 150	183	8 750
44	160	79	437	114	1 180	149	3 250	184	9 000
45	165	80	450	115	1 215	150	3 350	185	9 250
46	170	81	462	116	1 250	151	3 450	186	9 500
47	175	82	475	117	1 285	152	3 550	187	9 750
48	180	83	487	118	1 320	153	3 650	188	10 000
49	185	84	500	119	1 360	154	3 750	189	10 300
50	190	85	515	120	1 400	155	3 875	190	10 600
51	195	86	530	121	1 450	156	4 000	191	10 900
52	200	87	545	122	1 500	157	4 125	192	11 200
53	206	88	560	123	1 550	158	4 250	193	11 500
54	212	89	580	124	1 600	159	4 375	194	11 800
55	218	90	600	125	1 650	160	4 500	195	12 150
56	224	91	615	126	1 700	161	4 625	196	12 500
57	230	92	630	127	1 750	162	4 750	197	12 850
58	236	93	650	128	1 800	163	4 875	198	13 200
59	243	94	670	129	1 850	164	5 000	199	13 600
60	250	95	690	130	1 900	165	5 150	200	14 000
61	257	96	710	131	1 950	166	5 300		
62	265	97	730	132	2 000	167	5 450		
63	272	98	750	133	2 060	168	5 600		
64	280	99	775	134	2 120	169	5 800		

## Main applications – Radial Tyres

We offer a wide range of tyres for almost every piece of equipment and application – from high-horsepower tractors to massive harvesters, from field preparation to harvest.

Our extensive line of radial agricultural tyres offers solutions to all your needs, from our **High Capacity Tyres (HC)** and **Super Flexion Tyres (SFT)** series or our wide footprint **HC 70** and **AC 65** series tyres to our **AC 85** and **AC 90** series for row-crop applications.

The development of the **Silent Speed Tyres (SST)**, connects the outstanding field characteristics of a 65 series wide tyre with high comfort. Because with the SST the noise level in the operator's cab is reduced to a minimum. The **High Capacity Tyres (HC)** and **Super Flexion Tyres (SFT)** were developed primarily for powerful machines with over 180 hp. The extremely large volume of air ensures gentle ground handling when working with heavy loads. The new harvester tyres **HC 3000** and **SFT CHO** have been designed as an extremely powerful



	HC 2000	HC 1000	Super Flexion Tyres (SFT)	Silent Speed Tyres (SST)	AC 65	
<b>Product on page</b>	16	16	22	34	38	
<b>Type of tyre</b>	VF (Very High Flexion)	VF (Very High Flexion)	Super Flexion	Wide 65 series	Wide 65 series	
<b>Tractor (hp)</b>	> 180	–	> 180	< 220	< 220	
<b>Max speed</b>	65 km/h	65 km/h	65 km/h	65 km/h	65 km/h	
<b>Road performance, Transports</b>	++++	+++	+++++	+++++	++++	
<b>Field work</b>	+++++		+++++	++++	++++	
→ <b>Cultivating, tillage (high torque)</b>	+++++		+++++	++++	++++	
→ <b>Seedbed preparation (high load)</b>	+++++		+++++	++++	++++	
<b>Grassland application</b>	+++++		+++++	++++	++++	
<b>Row crop applications</b>		+++++		+	+	
<b>Harvester</b>						
<b>Vineyard &amp; fruit growing</b>		++++		+	++	

tyres for big combine harvesters. **HC 3000** and **SFT CHO** are capable of higher maximum loads; at the same time the tyre permits gentler ground handling in the field and more comfort on the road. For tractors with up to 200 hp, the Mitas range of radial tyres offers wide choice of all-rounders. The 85 series standard radial **AC 85** is ideally suited for wide-ranging applications in the field and on the road. The **HC 70** the new 70 series wide tyre, has higher load capacities than normally available in the 70 series segment; it therefore offers gentler

ground handling and can carry very heavy loads. The **AC 65** is a wide tyre with a 65% aspect ratio and is the ideal choice in this tractor segment, where it's about gentle ground handling and the ability to transport heavy loads, as well as traction and grassland suitability. The **AC 70 G** is the acknowledged grassland tyre in Mitas portfolio. The **AC 70 T** is particularly suited for heavy field work. In the smaller sizes it has proved itself in vine cultivation and fruit growing.



HC 70	AC 70 T	AC 70 G	AC 85	AC 85 / 90 Row Crop	HC 3000	CHO	SFT Harvester AC 70 H/G/N
46	52	60	64	74	84	88	94
Wide 70 series	Wide 70 series	Wide 70 series	Standard	Row Crop	Harvester (Cyclic Field Operation)	Harvester (Cyclic Harvesting Application)	Harvester
< 200	< 200	< 200	< 220	–	–	–	–
65 km/h	50 km/h	90 km/h	50 km/h	50 km/h	50 km/h	50 km/h	50 km/h
+++	++	++++	+++	++	+++	+++	+++
+++	+++	+++	+++				
++++	+++	++++	+++				
+++	++	+++	+++				
++++	++	+++	+++		++++	++++	++++
++	++	++	++++	++++			
					++++	++++	++++
+++	++++	+++	+++	++++			

+++++ excellent

++++ very good

+++ good

++ suitable

+ somewhat suitable



## HC 2000

LOAD CAPACITY	=====
TRACTION	=====
SOIL PROTECTION	=====
HANDLING ON ROAD	=====
COST EFFICIENCY	=====



## HC 1000

LOAD CAPACITY	=====
TRACTION	=====
SOIL PROTECTION	=====
HANDLING ON ROAD	=====
COST EFFICIENCY	=====



# HC 2000 – New VF (Very High Flexion) tyre

## For high-horsepower tractors



Lower inflation pressure provides **excellent traction efficiency**.



**Better ground protection** thanks to reduced soil compaction.



**Higher load capacity** for higher haulage efficiency.

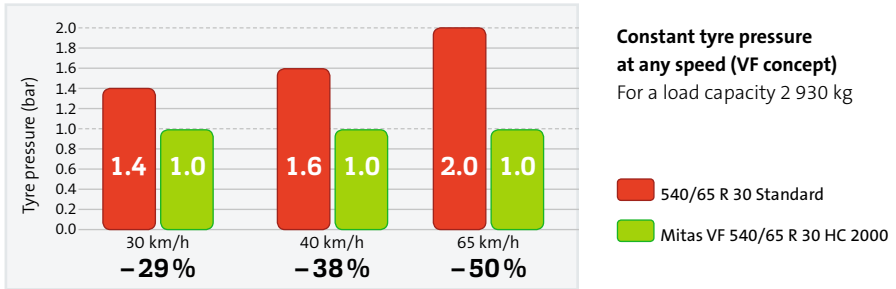

# HC 1000 – New narrow VF tyre

## For self-propelled sprayers



More lugs provide **better durability, longer service life and lower operation cost**.



**Higher maximum speed** (65 km/h) for less time on the road.



**Reduced soil compaction** for higher loads thanks to lower inflation pressure.

# HC 2000

## Technical data and load capacities

Tyre size	Service description L/SS	Rims * (permitted)	Section width (mm)	Overall diameter (mm)	Loaded static radius (mm)	Rolling circumference (mm)	Speed radius index	
<b>VF 420/85 R 28</b>	151 D	<b>DW 15 L</b> DW 14 L	440	1 430	640	4 260	675	
<b>VF 540/65 R 30</b>	155 D	<b>DW 20 B</b> DW 18 L W 16 L	549	1 464	660	4 410	700	
<b>VF 600/70 R 30</b>	165 D	<b>DW 21 B</b> DW 20 B	603 593	1 595	695	4 690	750	
<b>VF 380/85 R 34</b>	149 D	<b>DW 13 L</b> DW 12 L	390	1 535	695	4 570	725	
<b>VF 420/85 R 34</b>	154 D	<b>DW 14 L</b> DW 15 L	420 430	1 580	710	4 700	750	
<b>VF 380/95 R 38</b>	154 B	<b>DW 13 L</b> DW 12 L	394 384	1 670	735	4 950	800	
<b>VF 520/85 R 42</b>	174 B	<b>DW 18 L</b> DW 16 L	552	1 966	895	5 875	925	
<b>VF 650/65 R 42</b>	170 D	<b>DW 23 B</b> DW 21 B	650	1 913	860	5 740	925	
<b>VF 710/70 R 42</b>	179 D	<b>DW 25 B</b> DW 23 B	730 710	2 050	920	6 125	975	
<b>VF 480/80 R 46</b>	164 D	<b>DW 16 L</b> DW 15 L DW 18 L	479 469 499	1 936	870	5 800	925	
<b>VF 480/95 R 50</b>	170 B	<b>DW 16 L</b> DW 15 L DW 18 L	480 470 500	2 160	970	6 400	1075	
<b>VF 380/105 R 54</b>	168 B	<b>W 13 L</b> W 12 L	385 375	2 170	990	6 500	1075	

\* Further admissible rims on request

Load values for 0.4 bar and 0.6 bar are for calculating Dual and triple load values only.

For plowing with single driven tyres in the furrow, a minimum inflation pressure of 0.8 bar is required.

For intensive road transport at 65/50/40/30 km/h the pressure must be increased by 0.4 bar. Maximum inflation pressure should never be exceeded.

All load values are valid for ground slopes up to and including 20% (11°). When operating on slopes greater than 20%, please, contact the producer.

Tubeless tyres – may be used with a tube.

HC 2000



	Tyre load capacity (kg) at tyre pressure (bar)								Speed (km/h)
	0.4	0.6	0.8	1.0	1.2	1.4	1.6	2.4	
	1 385	1 660	2 200 1 935	2 515 2 215	2 830 2 490	3 145 2 765	<b>3 450</b> 3 035		0-65 0-65 Dual
	1 680	2 000	2 625 2 310	2 970 2 615	3 310 2 910	3 620 3 185	<b>3 875</b> 3 410		0-65 0-65 Dual
	2 080	2 495	3 305 2 910	3 780 3 325	4 250 3 740	4 725 4 160	<b>5 150</b> 4 530		0-65 0-65 Dual
	1 290	1 550	2 395 2 110	2 740 2 410	3 080 2 710	3 425 3 015	<b>3 750</b> 3 300		0-65 0-65 Dual
	1 505	1 810	2 390 2 100	2 730 2 400	3 070 2 700	3 410 3 000	<b>3 750</b> 3 300		0-50 0-50 Dual
	1 500	1 800	2 390 2 100	2 730 2 400	3 070 2 700	3 410 3 000	<b>3 750</b> 3 300		0-50 0-50 Dual
	2 300	2 760	3 660 3 220	4 180 3 680	4 705 4 140	5 225 4 600	5 750 5 060	<b>6 700</b> 5 895	0-50 0-50 Dual
	2 595	3 085	4 050 3 565	4 585 4 035	5 105 4 495	5 590 4 920	<b>6 000</b> 5 280		0-65 0-65 Dual
	3 075	3 690	4 895 4 305	5 590 4 920	6 290 5 535	6 990 6 150	<b>7 750</b> 6 820		0-65 0-65 Dual
	2 010	2 410	3 195 2 810	3 650 3 215	4 110 3 615	4 565 4 015	<b>5 000</b> 4 400		0-65 0-65 Dual
	2 435	2 925	3 875 3 410	4 430 3 900	4 985 4 385	5 540 4 875	<b>6 000</b> 5 280		0-50 0-50 Dual
	1 925	2 310	3 060 2 695	3 500 3 080	3 935 3 465	4 375 3 850	4 810 4 235	<b>5 600</b> 4 930	0-50 0-50 Dual

# HC 1000

## Technical data and load capacities

Tyre size	Service description L/SS	Rims * (permitted)	Section width (mm)	Overall diameter (mm)	Loaded static radius (mm)	Rolling circumference (mm)	Speed radius index
<b>VF 380/90 R 46</b>	173 D	<b>DW 13 L</b> DW 12 L	405 395	1 855	835	5 540	875
<b>VF 380/105 R 50</b>	176 D	<b>DW 13 L</b> DW 12 L	385 375	2 050	930	6 200	975
<b>VF 480/80 R 50</b>	181 D (184 A8)	<b>DW 16 L</b> DW 15 L DW 18 L	480 470 500	2 050	910	6 100	975
<b>VF 320/105 R 54</b>	169 D	<b>DW 11 L</b> DW 10 L	323 313	2 044	920	6 150	975

\* Further admissible rims on request

For intensive road transport at 65/50/40/30 km/h the pressure must be increased by 0.4 bar. Maximum inflation pressure should never be exceeded. All load values are valid for ground slopes up to and including 20% (11°). When operating on slopes greater than 20%, please, contact the producer. Tubeless tyres – may be used with a tube.

HC 1000



	Tyre load capacity (kg) at tyre pressure (bar)							Speed (km/h)
	1.0	1.6	2.4	3.2	3.6	4.0	4.4	
	2 800 2 465	3 875 3 410	4 625 4 070	5 425 4 775	5 775 5 080	6 125 5 390	<b>6 500</b> 5 720	0–65 0–65 Dual
	3 450 3 036	4 625 4 070	5 450 4 796	6 300 5 544	6 900 6 072	<b>7 100</b> 6 248		0–65 0–65 Dual
	3 870 3 405	5 320 4 680	5 840 5 140	6 220 5 475	7 365 6 470	<b>8 250</b> 7 260		0–65 0–65 Dual
	2 730 2 400	3 750 3 300	4 115 3 620	4 385 3 860	5 185 4 560	<b>5 800</b> 5 105		0–65 0–65 Dual

Tractor Radial Tyres | SFT

kW	22	44	66	88	110	132	162	191	>220
hp	30	60	90	120	150	180	220	260	>300



**SFT**



# Super Flexion Tyre (SFT)

## Maximum load capacity and traction for powerful machines



Developed for use on **high-horsepower tractors (> 180 hp) and combines.**



Flexible sidewalls allow low inflation pressures **for high load-carrying capacities**, gentle ground handling and higher yields.



**Maximum traction and outstanding productivity** thanks to transport speeds of 65 km/h and a large contact patch.

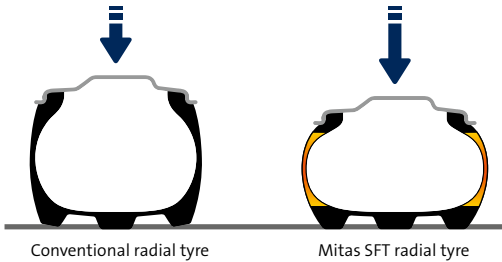

Conventional radial tyre

Mitas SFT radial tyre

Flexible sidewalls deliver maximum load capacity at the lowest possible inflation pressures for better traction and optimum soil protection, even with the heaviest equipment.



# Super Flexion Tyre SFT

## Technical data and load capacities

Tyre size	Service description LI/SS	Rims * (permitted)	Section width (mm)	Overall diameter (mm)	Loaded static radius (mm)	Rolling circumference (mm)	Speed radius index
<b>1000/50 R 25</b>	166 D (172 A8)	<b>36.0 TH</b> 36.0 VA	1 020	1 655	740	4 930	750
<b>1000/50 R 25</b>	175 D (178 A8)	<b>36.0 TH</b> 36.0 VA	1 020 1 020	1 655	740	4 930	750
<b>620/75 R 26</b>	166 A8 (166 B)	<b>DW 20 B</b>	625	1 590	689	4 660	750
<b>750/65 R 26</b>	166 D (169 A8)	<b>DW 23 B</b> DW 25 B	738 758	1 620	720	4 800	750
<b>540/65 R 28</b>	142 D (145 A8)	<b>W 16 L</b> W 18 L W 15 L	540 560 540	1 414	627	4 210	675
<b>600/65 R 28</b>	154 D (157 A8)	<b>W 18 L</b> DW 20 B	606 626	1 494	664	4 444	700
<b>600/70 R 28</b>	157 D (160 A8)	<b>W 18 L</b> DW 20 B	627 647	1 574	696	4 660	725
<b>600/70 R 28</b>	161 D (164 A8)	<b>W 18 L</b> DW 20 B	630 650	1 578	698	4 670	725





SFT

Tyre load capacity (kg) at tyre pressure (bar)												Speed (km/h)
0.4	0.6	0.8	1.0	1.2	1.4	1.6	2.0	2.4	2.8	3.2		
3 345 4 115	3 000 3 210 3 900	3 185	3 315	3 675	4 080	4 490	4 985	<b>5 300</b>	8 955		65	
		3 500	3 585	3 975	4 400	4 825	5 355	5 735			50	
		3 745	3 940	4 365	4 850	5 300	5 925	<b>6 300</b>			40	
		4 215	4 675	5 190	5 710	6 340	6 740				30	
		4 550	5 125	5 675	6 310	6 940	7 705	8 190			10	
	3 335 3 500 3 955	3 940	4 365	4 835	5 300	5 885	6 300	<b>6 900</b>	8 970		65	
		3 675	4 135	4 585	5 075	5 565	6 180	6 615			7 245	50
		3 830	4 315	4 780	5 295	5 800	6 445	6 900			<b>7 500</b>	40
		4 025	4 530	5 020	5 560	6 095	6 765	7 245			30	
		4 550	5 125	5 675	6 285	6 890	7 650	8 190			10	
		2 835	3 190	3 545	3 875	4 280	4 500	4 995	<b>5 300</b>	7 950	50	
		2 835	3 190	3 545	3 875	4 280	4 500	4 995	<b>5 300</b>		40	
		2 655	3 035	3 415	3 795	4 145	4 580	4 815	5 345		5 670	30
		2 755	3 150	3 540	3 935	4 300	4 750	4 995	5 540		25	
		3 050	3 490	3 925	4 360	4 765	5 265	5 535	6 140		20	
		3 225	4 535	4 150	5 670	5 040	5 565	5 850	6 490		10	
3 535	3 200 3 360 4 090	3 605	3 895	4 155	4 375	4 875	<b>5 300</b>	7 420			65	
		3 445	3 785	4 090	4 360	4 595	5 120				5 565	50
		3 595	3 950	4 265	4 545	4 750	5 340				<b>5 800</b>	40
		3 775	4 150	4 480	4 775	5 030	5 605	6 095			30	
		4 595	5 050	5 455	5 815	6 125	6 825	7 420			10	
2 165	1 960 2 060 2 505	2 210	2 385	2 530	<b>2 650</b>	3 975					65	
		2 320	2 505	2 655	2 785						50	
		2 420	2 615	2 770	<b>2 900</b>						40	
		2 315	2 540	2 910	3 050						30	
		2 815	3 095	3 340	3 545						10	
2 555	2 310 2 425 2 955	2 605	2 815	2 995	3 150	3 490	<b>3 750</b>	5 250	5 625		65	
		2 735	2 955	3 145	3 310	3 665	3 940				50	
		2 855	3 080	3 280	3 450	3 820	<b>4 125</b>				40	
		2 725	2 995	3 235	3 445	3 625	4 010	4 315			30	
		3 320	3 650	3 940	4 195	4 410	4 885	5 250			10	
2 730	2 505 2 630 3 200	2 900	3 175	3 380	3 550	3 900	<b>4 125</b>	5 775	6 190		65	
		3 045	3 335	3 550	3 730	4 095	4 330				50	
		3 175	3 480	3 700	3 875	4 270	<b>4 500</b>				40	
		2 990	3 335	3 655	3 885	4 085	4 485	4 745			30	
		3 640	4 060	4 450	4 730	4 970	5 460	5 775			10	
2 730	2 505 2 630 3 200	2 900	3 175	3 380	3 550	3 900	4 125	5 775	6 475		65	
		3 045	3 335	3 550	3 730	4 095	4 330				4 855	50
		3 175	3 480	3 700	3 875	4 270	4 500				<b>5 065</b>	40
		2 990	3 335	3 655	3 885	4 085	4 485	4 745	5 320		30	
		3 640	4 060	4 450	4 730	4 970	5 460	5 775			10	

## Super Flexion Tyre SFT (continued)

### Technical data and load capacities

Tyre size	Service description LI/SS	Rims * (permitted)	Section width (mm)	Overall diameter (mm)	Loaded static radius (mm)	Rolling circumference (mm)	Speed radius index
<b>540/65 R 30</b>	150 D (153 A8)	<b>W 16 L</b> W 18 L W 15 L	548 558 540	1 487	668	4 435	700
<b>600/70 R 30</b>	152 D (155 A8)	<b>W 18 L</b> DW 20 B	625 645	1 595	700	4 700	750
<b>620/75 R 30</b>	163 D (166 A8)	<b>W 20 B</b> W 18 L W 21 B	605 585 615	1 700	745	5 010	800
<b>710/55 R 30</b>	159 D (162 A8)	<b>DW 23 B</b>	690	1 500	674	4 475	725
<b>710/60 R 30</b>	162 D (165 A8)	<b>DW 23 B</b>	708	1 646	730	4 870	750
<b>750/55 R 30</b>	162 D (165 A8)	<b>DW 23 B</b>	720	1 584	712	4 725	750
<b>800/70 R 32</b>	175 A8 (172 B)	<b>DW 25 B</b> DW 27 B	762 784	1 932	845	5 630	925
<b>900/60 R 32</b>	176 A8 (173 B)	<b>DW 27 B</b> DW 30 B	857 890	1 905	850	5 700	925

SFT



	Tyre load capacity (kg) at tyre pressure (bar)											Speed (km/h)
	0.4	0.6	0.8	1.0	1.2	1.4	1.6	2.0	2.4	2.8	3.2	
2 235		2 020 2 125 2 585	2 180 2 270 2 385 2 905	2 280 2 395 2 495 2 620 3 190	2 465 2 585 2 695 2 830 3 450	2 605 2 735 2 855 3 000 3 650	2 725 2 860 3 000 3 135 3 815	3 080 3 235 3 375 3 545 4 315	<b>3 350</b> 3 520 <b>3 650</b> 3 855 4 690		5 025	65 50 40 30 10
2 810		2 575 2 705 3 295	2 815 2 935 3 080 3 750	2 985 3 135 3 270 3 435 4 180	3 270 3 435 3 585 3 765 4 580	3 430 3 605 3 755 3 945 4 805	<b>3 550</b> 3 730 <b>3 875</b> 4 085 4 970				5 325	65 50 40 30 10
2 440		2 465 2 590 2 930	2 760 2 880 3 025 3 415	3 005 3 155 3 290 3 455 3 905	3 380 3 550 3 700 3 885 4 395	3 755 3 940 4 110 4 315 4 880	4 125 4 330 4 515 4 745 5 365	4 555 4 780 4 985 5 235 5 920	<b>4 875</b> 5 120 <b>5 340</b> 5 605 6 340		7 315	65 50 40 30 10
2 670		2 440 2 560 3 115	2 655 2 765 2 905 3 540	2 805 2 945 3 075 3 230 3 930	3 065 3 220 3 360 3 525 4 295	3 365 3 530 3 680 3 865 4 710	3 650 3 835 4 000 4 200 5 110	4 045 4 250 4 430 4 655 5 665	<b>4 375</b> 4 595 <b>4 750</b> 5 030 6 125		6 565	65 50 40 30 10
2 885		2 635 2 770 3 370	2 870 2 990 3 140 3 825	3 035 3 185 3 325 3 490 4 250	3 315 3 480 3 630 3 815 4 645	3 605 3 785 3 945 4 145 5 045	3 875 4 070 4 250 4 455 5 425	4 385 4 605 4 800 5 040 6 135	<b>4 750</b> 4 990 <b>5 150</b> 5 465 6 650		7 125	65 50 40 30 10
2 905		2 655 2 790 3 395	2 890 3 015 3 165 3 855	3 060 3 210 3 350 3 515 4 280	3 340 3 510 3 660 3 845 4 680	3 675 3 860 4 025 4 225 5 145	4 000 4 200 4 375 4 600 5 600	4 400 4 620 4 820 5 060 6 160	<b>4 750</b> 4 990 <b>5 150</b> 5 465 6 650		7 125	65 50 40 30 10
		3 815 4 085 4 235 4 695 4 960	4 235 4 530 4 700 5 210 5 505	4 180 4 590 4 915 5 095 5 650 5 970	4 575 5 025 5 380 5 580 6 180 6 535	5 010 5 505 5 895 6 115 6 775 7 160	5 450 6 000 6 420 6 600 7 380 7 800	5 965 6 555 7 015 7 275 8 060 8 520	<b>6 300</b> <b>6 900</b> 7 385 7 660 8 485 8 970		10 350	50 40 30 25 20 10
		3 890 4 165 4 320 4 790 5 060	4 315 4 615 4 790 5 305 5 610	4 250 4 670 5 000 5 745 6 070	4 650 5 110 5 465 5 670 6 285 6 640	5 020 5 515 5 900 6 120 6 785 7 170	5 450 6 000 6 420 6 660 7 380 7 800	5 950 6 535 6 995 7 255 8 040 8 495	<b>6 500</b> <b>7 100</b> 7 595 7 880 8 735 9 230		10 650	50 40 30 25 20 10

## Super Flexion Tyre SFT (continued)

### Technical data and load capacities

Tyre size	Service description LI/SS	Rims * (permitted)	Section width (mm)	Overall diameter (mm)	Loaded static radius (mm)	Rolling circumference (mm)	Speed radius index
900/60 R 32	181 A8 (178 B)	DW 27 B DW 30 B	857 890	1 910	850	5 700	925
900/70 R 32	188 A8 (185 B)	DW 27 B DW 30 B	895 925	2 050	896	6 050	975
1050/50 R 32	178 A8 (178 B)	36.00 VA	1 015	1 890	855	5 640	875
1250/50 R 32	188 A8 (185 B)	40" 44"	1 180 1 220	2 020	890	6 000	975
1250/50 R 32	194 A8 (191 B)	40" 44"	1 180 1 220	2 020	890	6 000	975
650/60 R 34	159 D (162 A8)	DW 20 B DW 21 B DW 23 B	650 660 680	1 638	740	4 935	775
650/65 R 34	161 D (164 A8)	DW 20 B DW 21 B DW 23 B	664 674 694	1 719	769	5 116	825
710/60 R 34	164 D (167 A8)	DW 23 B	700	1 700	770	5 060	825

SFT



	Tyre load capacity (kg) at tyre pressure (bar)											Speed (km/h)
	0.4	0.6	0.8	1.0	1.2	1.4	1.6	2.0	2.4	2.8	3.2	
				4 250	4 650	5 020	5 450	5 950	6 500	7 025	<b>7 500</b>	50
		3 890	4 315	4 670	5 110	5 515	6 000	6 535	7 100	7 720	<b>8 250</b>	40
		4 165	4 615	5 000	5 465	5 900	6 420	6 995	7 595	8 260	8 830	30
		4 320	4 790	5 185	5 670	6 120	6 660	7 255	7 880	8 570	9 160	25
		4 790	5 305	5 745	6 285	6 785	7 380	8 040	8 735	9 495	10 150	20
		5 060	5 610	6 070	6 640	7 170	7 800	8 495	9 230	10 810	11 550	10
				5 055	5 530	6 060	6 700	7 215	7 750	8 415	<b>9 250</b>	50
		4 615	5 120	5 555	6 080	6 660	7 300	7 925	8 500	9 250	<b>10 000</b>	40
		4 940	5 480	5 945	6 505	7 125	7 810	8 480	9 095	9 895	10 700	30
		5 125	5 685	6 165	6 750	7 395	8 105	8 800	9 435	10 265	11 100	25
		5 675	6 300	6 830	7 475	8 195	8 980	9 750	10 455	11 375	12 300	20
		6 000	6 660	7 220	7 905	8 660	9 490	10 305	11 050	12 025	13 000	10
				5 045	5 515	5 955	6 500	7 055	<b>7 500</b>			50
		4 200	4 655	5 045	5 515	5 955	6 500	7 055	<b>7 500</b>			40
		4 495	4 985	5 395	5 900	6 370	6 955	7 550	8 025			30
		4 665	5 170	5 595	6 120	6 610	7 215	7 830	8 325			25
		5 170	5 730	6 200	6 785	7 320	7 995	8 680	9 225			20
		5 465	6 055	6 555	7 170	7 740	8 450	9 175	9 750	11 250		10
			5 020	5 655	6 265	6 960	7 750	8 500	<b>9 250</b>			50
		4 730	5 515	6 210	6 885	7 650	8 500	9 340	<b>10 000</b>			40
		5 060	5 905	6 645	7 265	8 185	9 095	9 995	10 700			30
		5 250	6 125	6 895	7 640	8 490	9 435	10 370	11 100			25
		5 815	6 785	7 640	8 470	9 410	10 455	11 490	12 300			20
		6 620	7 725	8 695	9 640	10 710	11 900	13 075	14 000			10
			5 020	5 655	6 265	6 960	7 750	8 500	9 250	10 040	<b>10 900</b>	50
		4 730	5 515	6 210	6 885	7 650	8 500	9 340	10 000	11 035	<b>11 800</b>	40
		5 060	5 905	6 645	7 265	8 185	9 095	9 995	10 700	11 805	12 625	30
		5 250	6 125	6 895	7 640	8 490	9 435	10 370	11 100	12 245	13 100	25
		5 815	6 785	7 640	8 470	9 410	10 455	11 490	12 300	13 570	14 515	20
		6 620	7 725	8 695	9 640	10 710	11 900	13 075	14 000	15 445	16 520	10
			2 645	2 795	3 055	3 355	3 650	4 040	<b>4 375</b>			65
		2 430	2 755	2 935	3 210	3 525	3 835	4 240	4 595			50
		2 550	2 895	3 060	3 345	3 675	4 000	4 420	<b>4 750</b>			40
	2 660	3 105	3 525	3 215	3 515	3 860	4 200	4 645	5 030			30
			3 915	4 280	4 700	5 110	5 655	6 125	6 565			10
			3 215	3 475	3 690	3 875	4 305	<b>4 625</b>				65
			3 375	3 645	3 875	4 070	4 520	4 855				50
		2 850	3 205	3 520	3 800	4 040	4 250	4 710	<b>5 000</b>			40
		2 995	3 365	3 695	3 995	4 245	4 455	4 950	5 320			30
	3 150	3 645	4 095	4 500	4 860	5 165	5 425	6 025	6 475	6 940		10
			3 205	3 505	3 820	4 125	4 625	<b>5 000</b>				65
			3 030	3 365	3 680	4 010	4 300	4 855	5 250			50
		2 785	3 160	3 510	3 835	4 185	4 500	5 060	<b>5 450</b>			40
		2 925	3 320	3 685	4 030	4 395	4 745	5 315	5 750			30
	3 050	3 560	4 040	4 490	4 905	5 350	5 775	6 470	7 000	7 500		10

## Super Flexion Tyre SFT (continued)

### Technical data and load capacities

Tyre size	Service description LI/SS	Rims * (permitted)	Section width (mm)	Overall diameter (mm)	Loaded static radius (mm)	Rolling circumference (mm)	Speed radius index
<b>650/65 R 38</b>	157 D (160 A8)	<b>W 18 L</b> DW 20 B	645 660	1 828	810	5 445	875
<b>650/75 R 38</b>	169 D (172 A8)	<b>DW 21 B</b> DW 20 B DW 23 B	667 657 687	1 944	872	5 795	925
<b>650/85 R 38</b>	173 D (176 A8)	<b>DW 23 B</b> DW 20 B DW 21 B	720 688 699	2 070	920	6 130	975
<b>710/70 R 38</b>	166 D (169 A8)	<b>DW 23 B</b>	736	1 958	870	5 780	925
<b>710/70 R 38</b>	171 D (174 A8)	<b>DW 23 B</b>	736	1 958	870	5 780	925
<b>800/70 R 38</b>	173 D (176 A8)	<b>DW 25 B</b> DW 27 B	765 787	2 052	911	6 090	975
<b>800/70 R 38</b>	178 D (181 A8)	<b>DW 25 B</b> DW 27 B	765 787	2 052	911	6 090	975
<b>900/60 R 38</b>	172 D (175 A8)	<b>DW 27 B</b> DW 30 B	870 900	2 060	918	6 115	975
<b>900/60 R 38</b>	178 D (181 A8)	<b>DW 27 B</b> DW 30 B	870 900	2 060	918	6 115	975

SFT



Tyre load capacity (kg) at tyre pressure (bar)											Speed (km/h)					
0.4	0.6	0.8	1.0	1.2	1.4	1.6	2.0	2.4	2.8	3.2						
3 315	3 000 3 150 3 835	3 230	3 380	3 655	3 905	<b>4 125</b>	6 190				65					
		3 370	3 550	3 835	4 100	4 330					50					
		3 540	3 705	4 000	4 275	<b>4 500</b>					40					
		4 310	3 890	4 200	4 490	4 745					30					
3 760	3 445 3 620 4 405	3 760	3 990	4 375	4 645	4 875	5 425	<b>5 800</b>	8 700		65					
		3 920	4 190	4 590	4 880	5 120	5 695	6 090			50					
		4 120	4 370	4 790	5 085	5 300	5 940	<b>6 300</b>			40					
		5 015	4 590	5 030	5 340	5 605	6 235	6 670			30					
4 210	3 855 4 050 4 930	4 210	4 465	4 895	5 195	5 450	6 075	<b>6 500</b>	9 750		65					
		4 390	4 690	5 140	5 455	5 725	6 375	6 825			50					
		4 610	4 890	5 360	5 690	6 000	6 650	<b>7 100</b>			40					
		5 610	5 135	5 630	5 975	6 270	6 985	7 475			30					
4 055	3 715 3 905 4 750	4 055	4 305	4 720	5 030	<b>5 300</b>	7 950				65					
		4 230	4 520	4 955	5 280	5 565					8 500			50		
		4 445	4 715	5 170	5 510	<b>5 800</b>								6 095	6 400	40
		5 410	4 950	5 425	5 785	6 095								6 740	7 420	30
4 055	3 715 3 905 4 750	4 055	4 305	4 720	5 030	5 300	5 805	<b>6 150</b>	9 225					65		
		4 230	4 520	4 955	5 280	5 565	6 095	6 460			50					
		4 445	4 715	5 170	5 510	5 800	6 355	<b>6 735</b>			40					
		5 410	4 950	5 425	5 785	6 095	6 675	7 075			30					
4 890	4 480 4 705 5 730	4 890	5 190	5 690	6 070	<b>6 400</b>	9 850				65					
		5 100	5 450	5 975	6 375	6 720					7 360	7 960	50			
		5 360	5 685	6 230	6 650	<b>7 010</b>					7 680	8 360	40			
		6 525	5 970	6 545	6 980	7 360					8 090	8 960	30			
4 890	4 480 4 705 5 730	4 890	5 190	5 690	6 070	6 400	7 035	<b>7 500</b>	11 250		65					
		5 100	5 450	5 975	6 375	6 720	7 390	7 875			50					
		5 360	5 685	6 230	6 650	7 010	7 705	<b>8 250</b>			40					
		6 525	5 970	6 545	6 980	7 360	8 090	8 625			30					
4 635	4 235 4 450 5 415	4 610	4 875	5 325	5 825	<b>6 300</b>	9 450				65					
		4 805	5 120	5 595	6 115	6 615					7 335	7 875	50			
		5 050	5 340	5 835	6 375	<b>6 900</b>					7 650	<b>8 250</b>	40			
		6 145	5 605	6 125	6 695	7 245					8 035	8 625	30			
4 635	4 235 4 450 5 415	4 610	4 875	5 325	5 825	6 300	6 985	<b>7 500</b>	11 250		65					
		4 805	5 120	5 595	6 115	6 615	7 335	7 875			50					
		5 050	5 340	5 835	6 375	6 900	7 650	<b>8 250</b>			40					
		6 145	5 605	6 125	6 695	7 245	8 035	8 625			30					
4 635	4 235 4 450 5 415	4 610	4 875	5 325	5 825	6 300	6 985	<b>7 500</b>	11 250		65					
		4 805	5 120	5 595	6 115	6 615	7 335	7 875			50					
		5 050	5 340	5 835	6 375	6 900	7 650	<b>8 250</b>			40					
		6 145	5 605	6 125	6 695	7 245	8 035	8 625			30					
4 635	4 235 4 450 5 415	4 610	4 875	5 325	5 825	6 300	6 985	<b>7 500</b>	11 250		65					
		4 805	5 120	5 595	6 115	6 615	7 335	7 875			50					
		5 050	5 340	5 835	6 375	6 900	7 650	<b>8 250</b>			40					
		6 145	5 605	6 125	6 695	7 245	8 035	8 625			30					
4 635	4 235 4 450 5 415	4 610	4 875	5 325	5 825	6 300	6 985	<b>7 500</b>	11 250		65					
		4 805	5 120	5 595	6 115	6 615	7 335	7 875			50					
		5 050	5 340	5 835	6 375	6 900	7 650	<b>8 250</b>			40					
		6 145	5 605	6 125	6 695	7 245	8 035	8 625			30					

## Super Flexion Tyre SFT (continued)

### Technical data and load capacities

Tyre size	Service description LI/SS	Rims * (permitted)	Section width (mm)	Overall diameter (mm)	Loaded static radius (mm)	Rolling circumference (mm)	Speed radius index
<b>580/85 R 42</b>	163 D (166 A8)	<b>W 18 L</b> DW 20 B DW 21 B	567 587 597	2 045	920	6 100	975
<b>650/75 R 42</b>	165 D (168 A8)	<b>DW 21 B</b> DW 20 B DW 23 B	650 640 670	2 035	905	6 090	975
<b>680/80 R 42</b>	180 D (183 A8)	<b>DW 21 B</b> DW 23 B DW 20 B	660 680 650	2 160	965	6 400	1 025
<b>710/70 R 42</b>	173 D (176 A8)	<b>DW 23 B</b> DW 25 B	731 751	2 070	935	6 150	975
<b>710/75 R 42</b>	175 D (178 A8)	<b>DW 23 B</b> DW 25 B	751 771	2 171	971	6 460	1 025
<b>900/60 R 42</b>	180 D (183 A8)	<b>DW 27 B</b> DW 30 B	860 890	2 150	970	6 440	1 025
<b>710/65 R 46</b>	174 D (177 A8)	<b>DW 23 B</b> DW 25 B	700 720	2 090	945	6 220	1 025
<b>IF 710/65 R 46</b>	183 D	<b>DW 25 B</b> DW 27 B	715 735	2 090	945	6 220	1 025

\* Further admissible rims on request

Load values for 0.4 bar and 0.6 bar are for calculating dual and triple load values only.

30 km/h (up to 40 km/h) load values also apply for low-speed high-torque field work.

For plowing with single driven tyres in the furrow, a minimum inflation pressure of 0.8 bar is required.

For intensive road transport at 65/50/40/30 km/h the pressure must be increased by 0.4 bar. Maximum inflation pressure should never be exceeded.

All load values are valid for ground slopes up to and including 20% (11°). When operating on slopes greater than 20%, please, contact the producer.

Tubeless tyres – may be used with a tube.



SFT



Tyre load capacity (kg) at tyre pressure (bar)											Speed (km/h)
0.4	0.6	0.8	1.0	1.2	1.4	1.6	2.0	2.4	2.8	3.2	
3 420	3 125 3 285 3 995	3 405 3 550 3 730 4 540	3 605 3 785 3 950 4 145 5 050	3 945 4 140 4 320 4 535 5 520	4 405 4 630 4 825 5 070 6 170	4 630 4 825 5 070 5 705 6 825	<b>4 875</b> 5 120 <b>5 300</b> 5 605 6 825	7 260			65 50 40 30 10
3 935	3 605 3 785 4 605	3 935 4 100 4 305 5 245	4 175 4 380 4 570 4 800 5 845	4 575 4 805 5 010 5 260 6 405	4 885 5 125 5 345 5 615 6 835	<b>5 150</b> 5 410 <b>5 600</b> 5 925 7 210	7 725				65 50 40 30 10
4 150	4 090 4 295 4 855	4 350 4 540 4 765 5 390	4 495 4 720 4 920 5 165 5 845	4 920 5 165 5 385 5 660 6 400	5 390 5 660 5 900 6 200 7 010	5 800 6 090 6 350 6 670 7 540	6 415 6 735 7 025 7 600 8 345	6 900 7 245 7 555 7 935 8 970	7 490 7 865 8 200 8 615 9 735	<b>8 000</b> <b>8 400</b> <b>8 760</b> 9 200 10 400	65 50 40 30 10
4 240	3 885 4 080 4 970	4 245 4 425 4 645 5 655	4 500 4 725 4 930 5 180 6 305	4 935 5 180 5 405 5 675 6 910	5 285 5 550 5 790 6 080 7 400	5 600 5 880 6 150 6 440 7 840	6 100 6 405 6 680 7 015 8 540	<b>6 500</b> 6 825 <b>7 100</b> 7 475 9 100	9 750		65 50 40 30 10
4 510	4 130 4 340 5 280	4 510 4 700 4 940 6 010	4 785 5 025 5 240 5 505 6 700	5 245 5 510 5 745 6 030 7 345	5 640 5 925 6 175 6 490 7 900	6 000 6 300 6 500 6 900 8 400	6 480 6 805 7 095 7 450 9 070	<b>6 900</b> 7 245 <b>7 500</b> 7 935 9 660	10 350		65 50 40 30 10
4 840	4 425 4 645 5 655	4 815 5 020 5 270 6 420	5 095 5 350 5 575 5 855 7 130	5 565 5 845 6 095 6 400 7 790	6 135 6 445 6 720 7 055 8 590	6 700 7 035 7 335 7 705 9 380	7 370 7 735 8 070 8 475 10 315	<b>8 000</b> 8 400 <b>8 750</b> 9 200 11 200	12 000		65 50 40 30 10
4 150	3 755 3 945 4 800	4 045 4 220 4 430 5 395	4 235 4 445 4 640 4 870 5 930	4 575 4 805 5 010 5 260 6 405	4 880 5 125 5 345 5 615 6 835	5 150 5 410 5 640 5 925 7 210	5 695 5 980 6 235 6 550 7 970	6 150 6 460 6 700 7 075 8 610	<b>6 700</b> 7 035 <b>7 300</b> 7 705 9 380		65 50 40 30 10
			4 625 4 070	5 150 4 530	5 675 4 995	6 150 5 410	6 800 5 985	7 300 6 425	8 000 7 040	<b>8 750</b> 7 700	65 65 Dual

kW	22	44	66	88	110	132	150	162	184	>220
hp	30	60	90	120	150	180	200	220	250	>300



## SST



# Silent Speed Tyre (SST)

## Fast, powerful and impressively quiet



**Noise reduction of up to 6 dB(A)** in the cab maximises concentration and minimises stress.



New casing construction ensures a **cost saving through reduced rolling resistance, long tyre life and high damage resistance.**



**Highest levels of productivity** achieved through the excellent characteristics of the 65 series profile and casing.



**Highest possible sustained speed capability** of up to 70 km/h.

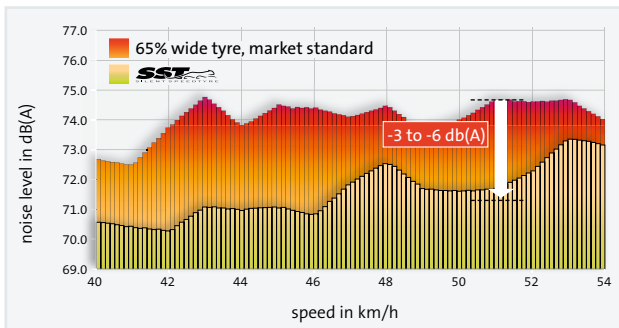

The Silent Speed Tyre SST traction tyre prevents the occurrence of the so-called “booming noise effect”. The SST reduces the noise level in the driver’s cab by 3 to 6 dB(A) compared with conventional rear axle tyres.



# Silent Speed Tyre SST

## Technical data and load capacities

Tyre size	Service description LI/SS	Rims * (permitted)	Section width (mm)	Overall diameter (mm)	Loaded static radius (mm)	Rolling circumference (mm)	Speed radius index
<b>600/65 R 38</b>	153 D (156 A8)	<b>W 18 L</b> DW 18 L W 16 L	591 591 571	1 746	782	5 215	825
<b>650/65 R 38</b>	157 D (160 A8)	<b>W 18 L</b> DW 20 B	623 643	1 822	810	5 420	875
<b>650/65 R 42</b>	165 D (168 A8)	<b>W 18 L</b> DW 20 B	616 636	1 930	870	5 790	925

\* Further admissible rims on request

Load values for 0.4 bar and 0.6 bar are for calculating dual and triple load values only.

30 km/h (up to 40 km/h) load values also apply for low-speed high-torque field work.

For plowing with single driven tyres in the furrow, a minimum inflation pressure of 0.8 bar is required.

For intensive road transport at 65/50/40/30 km/h the pressure must be increased by 0.4 bar. Maximum inflation pressure should never be exceeded.

All load values are valid for ground slopes up to and including 20% (11°). When operating on slopes greater than 20%, please, contact the producer.

Tubeless tyres – may be used with a tube.

SST



Tractor Radial Tyres

	Tyre load capacity (kg) at tyre pressure (bar)										Speed (km/h)
	0.4	0.6	0.8	1.0	1.2	1.4	1.6	2.0	2.4	3.0	
2 655		2 425 2 545 3 100	2 640 2 755 3 520	2 795 2 935 3 060 3 210 3 910	3 050 3 205 3 340 3 510 4 275	3 355 3 525 3 675 3 860 4 695	<b>3 650</b> 3 835 <b>4 000</b> 4 200 5 110	5 475			65 50 40 30 10
3 000		2 740 2 880 3 505	2 985 3 110 3 270 3 980	3 155 3 315 3 455 3 630 4 420	3 450 3 625 3 780 3 970 4 830	3 790 3 980 4 150 4 360 5 310	<b>4 125</b> 4 330 <b>4 500</b> 4 745 5 775	6 190			65 50 40 30 10
3 145		2 875 3 015 3 675	3 125 3 260 3 425 4 170	3 310 3 475 3 625 3 805 4 635	3 615 3 795 3 960 4 160 5 065	3 940 4 140 4 315 4 530 5 515	4 250 4 465 4 625 4 890 5 950	4 765 5 005 5 220 5 480 6 675	<b>5 150</b> 5 410 <b>5 600</b> 5 925 7 210	7 725	65 50 40 30 10

kW	22	44	66	88	110	132	150	162	184	>220
hp	30	60	90	120	150	180	200	220	250	>300



## AC 65



# AC 65

Versatile wide tyre that delivers efficiency in field applications and in transport



**Extremely economical** thanks to very good traction and low-wear tread compound.



**Very high load-carrying capacity** through large volume of air.



**Very gentle ground handling** thanks to a very large contact patch and exceptional load-carrying capacities.



**Greater operator comfort** at road speeds as high as 65 km/h.



Standard tyre



Wide tyre AC 65

The very large contact patch permits high traction and gentle ground handling, even with heavy equipment.



## AC 65

### Technical data and load capacities

Tyre size	Service description LI/SS	Rims * (permitted)	Section width (mm)	Overall diameter (mm)	Loaded static radius (mm)	Rolling circumference (mm)	Speed radius index
<b>320/65 R 16</b>	117 D (120 A8)	<b>W 10</b> W 9 W 11	316 310 326	844	373	2 497	390
<b>420/65 R 20 <sup>1)</sup></b>	125 D (128 A8)	<b>W 13</b> W 12 W 11	408 398 388	1 050	469	3 146	500
<b>420/65 R 20</b>	125 D (128 A8)	<b>W 13</b> W 12 W 11	415 405 395	1 050	469	3 146	500
<b>440/65 R 24</b>	128 D (131 A8)	<b>W 14 L</b> W 13 W 12	445 435 425	1 196	543	3 585	575
<b>480/65 R 24</b>	133 D (136 A8)	<b>W 15 L</b> W 14 L W 13	473 463 453	1 256	570	3 764	600
<b>540/65 R 24</b>	140 D (143 A8)	<b>W 16 L</b> W 18 L W 15 L	523 543 513	1 317	590	3 922	625
<b>540/65 R 24</b>	146 D (149 A8)	<b>W 16 L</b> W 18 L W 15 L	523 543 513	1 317	590	3 922	625
<b>440/65 R 28</b>	131 D (134 A8)	<b>W 14 L</b> W 13 W 12	447 437 427	1 292	594	3 896	625





AC 65

	Tyre load capacity (kg) at tyre pressure (bar)										Speed (km/h)
	0.4	0.6	0.8	1.0	1.2	1.4	1.6	2.0	2.4	3.0	
625		585 615 750	655 685 715 875	715 750 820 1 000	800 840 920 1 125	890 935 975 1 020 1 245	975 1 025 1 060 1 120 1 365	1 135 1 195 1 245 1 305 1 590	<b>1 285</b> 1 350 <b>1 400</b> 1 480 1 800	1 930	65 50 40 30 10
1 130		1 045 1 095 1 335	1 145 1 195 1 255 1 530	1 225 1 285 1 340 1 410 1 715	1 355 1 420 1 480 1 555 1 895	1 500 1 575 1 645 1 725 2 100	<b>1 650</b> 1 735 <b>1 800</b> 1 900 2 310	2 475			65 50 40 30 10
1 130		1 045 1 095 1 335	1 145 1 195 1 255 1 530	1 225 1 285 1 340 1 410 1 715	1 355 1 420 1 480 1 555 1 895	1 500 1 575 1 645 1 725 2 100	<b>1 650</b> 1 735 <b>1 800</b> 1 900 2 310	2 475			65 50 40 30 10
1 330		1 215 1 280 1 555	1 325 1 380 1 450 1 765	1 400 1 470 1 535 1 610 1 960	1 530 1 610 1 675 1 760 2 145	1 670 1 750 1 830 1 920 2 335	<b>1 800</b> 1 890 <b>1 950</b> 2 070 2 520	2 700			65 50 40 30 10
1 525		1 395 1 465 1 780	1 515 1 580 1 660 2 020	1 605 1 685 1 755 1 845 2 245	1 755 1 840 1 920 2 015 2 455	1 910 2 005 2 090 2 195 2 675	<b>2 060</b> 2 165 <b>2 240</b> 2 370 2 885	3 090			65 50 40 30 10
1 835		1 675 1 760 2 140	1 825 1 900 1 995 2 430	1 930 2 025 2 115 2 220 2 700	2 110 2 215 2 310 2 425 2 950	2 310 2 425 2 525 2 655 3 230	<b>2 500</b> 2 625 <b>2 725</b> 2 875 3 500	3 750			65 50 40 30 10
1 835		1 675 1 760 2 140	1 825 1 900 1 995 2 430	1 930 2 025 2 115 2 220 2 700	2 110 2 215 2 310 2 425 2 950	2 310 2 425 2 525 2 655 3 230	2 500 2 625 2 740 2 875 3 500	2 780 2 915 3 040 3 195 3 890	<b>3 000</b> 3 150 <b>3 250</b> 3 450 4 200	4 500	65 50 40 30 10
1 430		1 305 1 375 1 670	1 425 1 485 1 560 1 895	1 505 1 580 1 650 1 730 2 110	1 645 1 725 1 800 1 890 2 305	1 800 1 890 1 970 2 070 2 520	<b>1 950</b> 2 050 <b>2 120</b> 2 245 2 730	2 925			65 50 40 30 10

## AC 65 (continued)

### Technical data and load capacities

Tyre size	Service description LI/SS	Rims * (permitted)	Section width (mm)	Overall diameter (mm)	Loaded static radius (mm)	Rolling circumference (mm)	Speed radius index
<b>480/65 R 28</b>	136 D (139 A8)	<b>W 15 L</b> W 14 L W 13	475 465 455	1 355	616	4 064	650
<b>540/65 R 28</b>	142 D (145 A8)	<b>W 16 L</b> W 18 L W 15 L	530 550 520	1 410	624	4 145	675
<b>600/65 R 28</b>	147 D (150 A8)	<b>W 18 L</b> DW 18 L W 16 L	590 590 570	1 485	661	4 411	700
<b>540/65 R 30</b>	150 D (153 A8)	<b>W 16 L</b> W 18 L W 15 L	526 546 516	1 485	664	4 419	700
<b>600/65 R 30</b>	149 D (152 A8)	<b>W 18 L</b> DW 18 L W 16 L	590 590 570	1 549	687	4 591	725
<b>540/65 R 34</b>	145 D (148 A8)	<b>W 16 L</b> W 18 L W 15 L	526 546 516	1 580	709	4 709	750
<b>600/65 R 34</b>	151 D (154 A8)	<b>W 18 L</b> DW 18 L W 16 L	592 592 572	1 648	737	4 904	775
<b>540/65 R 38</b>	147 D (150 A8)	<b>W 16 L</b> W 18 L W 15 L	517 537 507	1 678	760	5 023	800



AC 65

	Tyre load capacity (kg) at tyre pressure (bar)										Speed (km/h)
	0.4	0.6	0.8	1.0	1.2	1.4	1.6	2.0	2.4	3.0	
1 635		1 495 1 570 1 910	1 625 1 695 1 780 2 165	1 720 1 805 1 885 1 980 2 410	1 880 1 975 2 060 2 160 2 630	2 060 2 165 2 260 2 370 2 885	<b>2 240</b> 2 350 <b>2 430</b> 2 575 3 135	3 360			65 50 40 30 10
1 960		1 790 1 880 2 290	1 950 2 035 2 135 2 600	2 065 2 165 2 260 2 375 2 890	2 255 2 365 2 470 2 595 3 155	2 455 2 580 2 690 2 825 3 440	<b>2 650</b> 2 785 <b>2 900</b> 3 050 3 710	3 975			65 50 40 30 10
2 310		2 110 2 220 2 700	2 300 2 395 2 515 3 065	2 430 2 555 2 665 2 795 3 405	2 660 2 790 2 910 3 055 3 720	2 875 3 020 3 145 3 305 4 025	<b>3 075</b> 3 230 <b>3 350</b> 3 535 4 305	4 615			65 50 40 30 10
2 020		1 850 1 940 2 365	2 010 2 100 2 205 2 680	2 130 2 235 2 330 2 450 2 980	2 325 2 440 2 545 2 675 3 255	2 545 2 675 2 790 2 930 3 565	2 725 2 860 3 000 3 135 3 815	3 080 3 235 3 375 3 545 4 315	<b>3 350</b> 3 520 <b>3 650</b> 3 855	5 025	65 50 40 30 10
2 380		2 175 2 285 2 780	2 370 2 470 2 595 3 160	2 505 2 630 2 745 2 880 3 510	2 740 2 875 3 000 3 150 3 835	3 000 3 150 3 285 3 450 4 200	<b>3 250</b> 3 415 <b>3 550</b> 3 740 4 550	4 875			65 50 40 30 10
2 145		1 960 2 055 2 505	2 130 2 225 2 335 2 845	2 255 2 370 2 470 2 595 3 160	2 465 2 590 2 700 2 835 3 450	2 690 2 820 2 945 3 090 3 765	<b>2 900</b> 3 045 <b>3 150</b> 3 335 4 060	4 350			65 50 40 30 10
2 520		2 300 2 420 2 945	2 505 2 615 2 745 3 340	2 650 2 785 2 905 3 050 3 710	2 900 3 045 3 175 3 330 4 055	3 180 3 335 3 480 3 655 4 450	<b>3 450</b> 3 625 <b>3 780</b> 3 970 4 830	5 175			65 50 40 30 10
2 260		2 065 2 170 2 640	2 250 2 345 2 465 3 000	2 380 2 500 2 605 2 735 3 330	2 600 2 730 2 850 2 990 3 640	2 845 2 985 3 115 3 270 3 980	<b>3 075</b> 3 230 <b>3 350</b> 3 535 4 305	4 615			65 50 40 30 10

## AC 65 (continued)

### Technical data and load capacities

Tyre size	Service description LI/SS	Rims * (permitted)	Section width (mm)	Overall diameter (mm)	Loaded static radius (mm)	Rolling circumference (mm)	Speed radius index
<b>600/65 R 38</b>	153 D (156 A8)	<b>W 18 L</b> DW 18 L W 16 L	590 590 570	1 759	792	5 251	825
<b>650/65 R 38</b>	157 D (160 A8)	<b>W 18 L</b> DW 20 B	618 638	1 828	810	5 416	875
<b>650/65 R 38</b>	166 D (169 A8)	<b>W 18 L</b> DW 20 B	620 640	1 840	828	5 461	875
<b>710/70 R 38</b>	166 D (169 A8)	<b>DW 23 B</b> DW 25 B	708 728	1 925	857	5 716	925
<b>650/65 R 42</b>	165 D (168 A8)	<b>DW 20 B</b> DW 18L	641 621	1 936	860	5 798	925

\* Further admissible rims on request

<sup>1)</sup> Tread pattern AC 65 N

Load values for 0.4 bar and 0.6 bar are for calculating dual and triple load values only.

30 km/h (up to 40 km/h) load values also apply for low-speed high-torque field work.

For plowing with single driven tyres in the furrow, a minimum inflation pressure of 0.8 bar is required.

For intensive road transport at 65/50/40/30 km/h the pressure must be increased by 0.4 bar. Maximum inflation pressure should never be exceeded.

All load values are valid for ground slopes up to and including 20% (11°). When operating on slopes greater than 20%, please, contact the producer.

Tubeless tyres – may be used with a tube.



AC 65

	Tyre load capacity (kg) at tyre pressure (bar)										Speed (km/h)
	0.4	0.6	0.8	1.0	1.2	1.4	1.6	2.0	2.4	3.0	
2 655		2 425 2 545 3 100	2 640 2 755 2 890 3 520	2 795 2 935 3 060 3 210 3 910	3 050 3 205 3 340 3 510 4 275	3 355 3 525 3 675 3 860 4 695	<b>3 650</b> 3 835 <b>4 000</b> 4 200 5 110	5 475			65 50 40 30 10
3 000		2 740 2 880 3 505	2 985 3 110 3 270 3 980	3 155 3 315 3 455 3 630 4 420	3 450 3 625 3 780 3 970 4 830	3 790 3 980 4 150 4 360 5 310	<b>4 125</b> 4 330 <b>4 500</b> 4 745 5 775	6 190			65 50 40 30 10
3 000		2 740 2 880 3 505	2 985 3 110 3 270 3 980	3 155 3 315 3 455 3 630 4 420	3 450 3 625 3 780 3 970 4 830	3 790 3 980 4 150 4 360 5 310	4 125 4 330 4 500 4 745 5 775	4 530 4 760 4 960 5 210 6 345	4 875 5 120 5 300 5 605 6 825	(2.8 bar) <b>5 300</b> 5 565 <b>5 800</b> 6 095 7 420	65 50 40 30 10
3 765		3 445 3 620 4 405	3 755 3 915 4 110 5 005	3 975 4 175 4 350 4 570 5 565	4 345 4 565 4 760 5 000 6 085	4 825 5 065 5 280 5 550 6 755	<b>5 300</b> 5 565 <b>5 800</b> 6 095 7 420	7 950			65 50 40 30 10
3 145		2 875 3 015 3 675	3 125 3 260 3 425 4 170	3 310 3 475 3 625 3 805 4 635	3 615 3 795 3 960 4 160 5 065	3 940 4 140 4 315 4 530 5 515	4 250 4 465 4 625 4 890 5 950	4 765 5 005 5 220 5 480 6 675	<b>5 150</b> 5 410 <b>5 600</b> 5 925 7 210	7 725	65 50 40 30 10

kW	22	44	66	88	110	132	162	191	>220
hp	30	60	90	120	150	180	220	260	>300



## HC 70



# HC 70

The all-round benchmark in the 70 series wide tyre segment with higher load capacities than conventional 70 series



**Low operating costs** thanks to minimised slip, plus gentle ground handling through high load capacity.



**Comfortable, safe road performance**, thanks to wide tyre shoulders.



Particularly **gentle handling of grassland** through rounded shoulder design and lug edges.

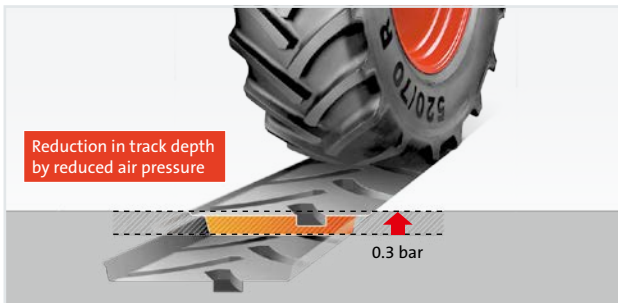

Low track depth and low operating costs, thanks to reduced inflation pressure and good traction.



# HC 70

## Technical data and load capacities

Tyre size	Service description L/SS	Rims * (permitted)	Section width (mm)	Overall diameter (mm)	Loaded static radius (mm)	Rolling circumference (mm)	Speed radius index
<b>320/70 R 24</b>	116 D (119 A8)	<b>W 10</b> W 11 W 9	325 335 315	1 115	491	3 295	525
<b>360/70 R 24</b>	122 D (125 A8)	<b>W 11</b> W 12 W 10	365 375 355	1 142	508	3 398	550
<b>380/70 R 24</b>	125 D (128 A8)	<b>W 12</b> W 13 W 11	395 405 385	1 191	533	3 545	575
<b>420/70 R 24</b>	130 D (133 A8)	<b>W 13</b> W 14 L W 12	443 453 433	1 245	552	3 695	600
<b>480/70 R 24</b>	138 D (141 A8)	<b>W 15 L</b> W 16 L W 14 L	502 512 492	1 320	574	3 896	625
<b>380/70 R 28</b>	127 D (130 A8)	<b>W 12</b> W 13 W 11	395 405 385	1 292	576	3 850	625
<b>420/70 R 28</b>	133 D (136 A8)	<b>W 13</b> W 14 L W 12	438 448 428	1 350	610	4 038	650
<b>480/70 R 28</b>	140 D (143 A8)	<b>W 15 L</b> W 16 L W 14 L	498 508 488	1 422	630	4 220	675
<b>420/70 R 30</b>	134 D (137 A8)	<b>W 13</b> W 14 L W 12	433 443 423	1 392	622	4 150	675





HC 70

	Tyre load capacity (kg) at tyre pressure (bar)										Speed (km/h)
	0.6	0.8	1.0	1.2	1.4	1.6	2.0	2.4	2.8	3.2	
			945	1 035	1 140	<b>1 250</b>					65
		890	990	1 085	1 200	1 315					50
	820	930	1 035	1 190	1 250	<b>1 360</b>					40
	860	975	1 085	1 445	1 315	1 440					30
	1 045	1 190	1 320	2 170	1 600	1 750	1 875				10
			1 130	1 235	1 370	<b>1 500</b>					65
		1 065	1 185	1 295	1 435	1 575					50
	980	1 110	1 235	1 355	1 500	<b>1 650</b>					40
	1 030	1 170	1 300	1 420	1 575	1 725					30
	1 250	1 420	1 580	1 730	1 915	2 100	2 250				10
			1 225	1 340	1 495	<b>1 650</b>					65
		1 160	1 290	1 410	1 570	1 735					50
	1 065	1 210	1 345	1 470	1 640	<b>1 800</b>					40
	1 115	1 270	1 410	1 545	1 720	1 900					30
	1 360	1 545	1 720	1 880	2 095	2 310	2 475				10
			1 430	1 565	1 735	<b>1 900</b>					65
		1 350	1 505	1 645	1 820	1 995					50
	1 240	1 410	1 570	1 715	1 900	<b>2 060</b>					40
	1 305	1 480	1 645	1 800	1 995	2 185					30
	1 585	1 805	2 005	2 190	2 425	2 660	2 850				10
			1 765	1 930	2 145	<b>2 360</b>					65
		1 665	1 850	2 025	2 250	2 480					50
	1 530	1 735	1 930	2 110	2 350	<b>2 575</b>					40
	1 605	1 825	2 030	2 220	2 465	2 715					30
	1 955	2 220	2 470	2 700	3 000	3 305	3 540				10
			1 320	1 445	1 600	<b>1 750</b>					65
		1 245	1 385	1 515	1 675	1 840					50
	1 145	1 300	1 445	1 580	1 750	<b>1 900</b>					40
	1 200	1 365	1 520	1 660	1 835	2 015					30
	1 465	1 660	1 850	2 020	2 335	2 450	2 625				10
			1 535	1 680	1 870	<b>2 060</b>					65
		1 450	1 615	1 765	1 965	2 165					50
	1 335	1 515	1 685	1 840	2 050	<b>2 240</b>					40
	1 400	1 590	1 770	1 935	2 150	2 370					30
	1 705	1 935	2 150	2 355	2 620	2 885	3 090				10
			1 890	2 065	2 285	<b>2 500</b>					65
		1 780	2 980	2 170	2 395	2 625					50
	1 635	1 860	2 065	2 260	2 500	<b>2 725</b>					40
	1 720	1 950	2 170	2 375	2 625	2 875					30
	2 090	2 375	2 645	2 890	3 195	3 500	3 750				10
			1 590	1 735	1 930	<b>2 120</b>					65
		1 500	1 670	1 825	2 025	2 225					50
	1 375	1 565	1 740	1 905	2 110	<b>2 300</b>					40
	1 445	1 645	1 825	2 000	2 220	2 440					30
	1 760	2 000	2 225	2 430	2 700	2 970	3 180				10

## HC 70 (continued)

### Technical data and load capacities

Tyre size	Service description LI/SS	Rims * (permitted)	Section width (mm)	Overall diameter (mm)	Loaded static radius (mm)	Rolling circumference (mm)	Speed radius index
<b>480/70 R 30</b>	141 D (144 A8)	<b>W 15 L</b> W 16 L W 14 L	499 509 489	1 474	655	4 380	700
<b>480/70 R 30</b>	152 D (155 A8)	<b>W 15 L</b> W 16 L W 14 L	499 509 489	1 474	655	4 380	700
<b>480/70 R 34</b>	143 D (146 A8)	<b>W 15 L</b> W 16 L W 14 L	494 504 484	1 590	704	4 710	750
<b>520/70 R 34</b>	148 D (151 A8)	<b>W 16 L</b> W 18 L W 15 L	539 559 529	1 651	735	4 905	775
<b>480/70 R 38</b>	145 D (148 A8)	<b>W 15 L</b> W 16 L W 14 L	496 506 486	1 699	768	5 082	800
<b>520/70 R 38</b>	150 D (153 A8)	<b>W 16 L</b> W 18 L W 15 L	536 556 524	1 751	790	5 232	825
<b>580/70 R 38</b>	155 D (158 A8)	<b>W 18 L</b>	596	1 857	822	5 500	875

\* Further admissible rims on request

Load values for 0.6 bar are for calculating dual and triple load values only.

30 km/h (up to 40 km/h) load values also apply for low-speed high-torque field work.

For plowing with single driven tyres in the furrow, a minimum inflation pressure of 0.8 bar is required.

For intensive road transport at 65/50/40/30 km/h the pressure must be increased by 0.4 bar. Maximum inflation pressure should never be exceeded.

All load values are valid for ground slopes up to and including 20% (11°). When operating on slopes greater than 20%, please, contact the producer.

Tubeless tyres – may be used with a tube.



HC 70

	Tyre load capacity (kg) at tyre pressure (bar)										Speed (km/h)
	0.6	0.8	1.0	1.2	1.4	1.6	2.0	2.4	2.8	3.2	
1 690 1 775 2 160	1 840 1 920 2 015 2 455	1 950 2 045 2 135 2 240 2 725	2 130 2 235 2 335 2 450 2 985	2 355 2 470 2 580 2 705 3 295	<b>2 575</b> 2 705 <b>2 800</b> 2 960 3 605		3 865				65 50 40 30 10
1 690 1 775 2 160	1 840 1 920 2 015 2 455	1 950 2 045 2 135 2 240 2 725	2 130 2 235 2 335 2 450 2 985	2 355 2 470 2 580 2 705 3 295	2 575 2 705 2 800 2 960 3 605	2 870 3 015 3 145 3 300 4 020	3 075 3 230 3 365 3 535 4 305	3 335 3 500 3 650 3 835 4 670	<b>3 550</b> 3 730 <b>3 885</b> 4 085 4 970	65 50 40 30 10	
1 790 1 880 2 290	1 950 2 035 2 135 2 600	2 065 2 170 2 265 2 375 2 895	2 260 2 375 2 475 2 600 3 165	2 495 2 620 2 730 2 870 3 490	<b>2 725</b> 2 860 <b>3 000</b> 3 135 3 815	4 090				65 50 40 30 10	
2 025 2 125 2 590	2 205 2 300 2 415 2 940	2 450 2 555 2 685 3 270	2 680 2 795 2 935 3 575	2 850 2 995 3 120 3 280 3 990	<b>3 150</b> 3 310 <b>3 450</b> 3 625 4 410	4 725				65 50 40 30 10	
1 890 1 985 2 420	2 060 2 150 2 255 2 745	2 180 2 290 2 390 2 510 3 055	2 385 2 505 2 615 2 745 3 340	2 645 2 775 2 895 3 040 3 700	<b>2 900</b> 3 045 <b>3 150</b> 3 335 4 060	4 350				65 50 40 30 10	
2 135 2 240 2 730	2 325 2 525 2 545 3 100	2 460 2 585 2 695 2 830 3 445	2 695 2 825 2 950 3 095 3 770	3 020 3 170 3 305 3 470 4 225	<b>3 350</b> 3 520 <b>3 650</b> 3 855 4 690	5 025				65 50 40 30 10	
2 520 2 645 3 225	2 745 2 865 3 005 3 660	2 910 3 055 3 185 3 345 4 070	3 180 3 340 3 480 3 655 4 450	3 530 3 705 3 865 4 055 4 940	<b>3 875</b> 4 070 <b>4 250</b> 4 455 5 425	5 815				65 50 40 30 10	

kW	22	44	66	88	110	132	150	162	184	>220
hp	30	60	90	120	150	180	200	220	250	>300



## AC 70 T



# AC 70 T

## Wide traction tyre for heavy field work



**Deep lugs provide** greater traction **in the field.**



**Outstanding self-cleaning** between lugs reduces slip and improves pulling power.



**Tremendous durability** and outstanding traction make this tyre very economical.

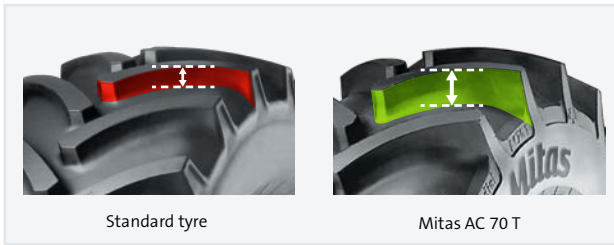

Standard tyre

Mitas AC 70 T

Deep high-grip lugs transmit traction, even on wet ground.



# AC 70 T

## Technical data and load capacities

Tyre size	Service description LI/SS	Rims * (permitted)	Section width (mm)	Overall diameter (mm)	Loaded static radius (mm)	Rolling circumference (mm)	Speed radius index	
<b>200/70 R 16</b>	94 A8 (94 B)	<b>W 6</b>	198	691	311	2 050	330	
		W 8	218					
		W 7	208					
<b>240/70 R 16</b>	104 A8 (104 B)	<b>W 8</b>	244	737	331	2 192	350	
		W 9	254					
		W 7	234					
<b>260/70 R 16</b>	109 A8 (109 B)	<b>W 8</b>	261	770	345	2 290	360	
		W 9	271					
<b>280/70 R 16</b>	112 A8 (112 B)	<b>W 9</b>	285	798	358	2 390	390	
		W 10	295					
		W 8	275					
<b>280/70 R 18</b>	114 A8 (114 B)	<b>W 9</b>	280	852	383	2 545	410	
		W 10	290					
		W 8	270					
<b>260/70 R 20</b>	113 A8 (113 B)	<b>W 8</b>	262	882	401	2 650	410	
		W 9	272					
		W 10	282					
<b>280/70 R 20</b>	116 A8 (116 B)	<b>W 9</b>	276	906	411	2 725	425	
		W 10	286					
		W 8	266					
<b>300/70 R 20</b>	110 A8 (110 B)	<b>W 9</b>	290	942	428	2 825	450	
		W 10	300					
<b>320/70 R 20</b>	113 A8 (113 B)	<b>W 10</b>	320	972	441	2 916	475	
		W 11	330					
		W 9	310					
<b>360/70 R 20</b>	120 A8 (120 B)	<b>W 11</b>	360	1 040	461	3 083	500	
		W 12	370					
		W 10	350					



AC 70 T

	Tyre load capacity (kg) at tyre pressure (bar)									Speed (km/h)
	0.6	0.8	1.0	1.2	1.4	1.6	2.0	2.4	3.0	
			410	445	480	510	565	<b>670</b>		50
		375	410	445	480	510	565	<b>670</b>		40
	355	400	440	480	510	545	605	715		30
	435	485	535	580	625	660	735	870	1 005	10
			545	590	630	670	745	<b>900</b>		50
		495	545	590	630	670	745	<b>900</b>		40
	470	530	580	630	675	720	795	965		30
	570	640	705	765	820	870	965	1 170	1 350	10
			615	665	715	760	840	<b>1 030</b>		50
		560	615	665	715	760	840	<b>1 030</b>		40
	530	595	660	710	765	810	900	1 100		30
	645	725	800	865	930	985	1 095	1 340	1 545	10
			690	750	800	850	940	<b>1 120</b>		50
		625	690	750	800	850	940	<b>1 120</b>		40
	600	670	740	800	860	910	1 010	1 200		30
	720	815	900	970	1 040	1 110	1 230	1 460	1 680	10
			725	790	845	900	995	<b>1 180</b>		50
		660	725	790	845	900	995	<b>1 180</b>		40
	630	705	775	845	905	960	1 065	1 265		30
	765	860	945	1 025	1 100	1 165	1 295	1 535	1 770	10
			620	690	770	850	995	<b>1 150</b>		50
		550	620	690	770	850	995	<b>1 150</b>		40
	515	590	665	740	825	910	1 065	1 230		30
	670	775	870	965	1 080	1 190	1 395	1 610	1 725	10
			765	830	890	945	1 045	<b>1 250</b>		50
		695	765	830	890	945	1 045	<b>1 250</b>		40
	660	740	815	885	950	1 010	1 120	1 340		30
	805	900	995	1 075	1 155	1 230	1 360	1 625	1 875	10
			850	920	985	<b>1 060</b>				50
		770	850	920	985	<b>1 060</b>				40
	735	825	910	985	1 055	1 135				30
	890	1 000	1 105	1 200	1 280	1 380	1 590			10
			935	1 015	1 090	<b>1 150</b>				50
		850	935	1 015	1 090	<b>1 150</b>				40
	810	910	1 000	1 090	1 165	1 230				30
	985	1 105	1 220	1 320	1 420	1 495	1 725			10
			1 125	1 220	1 305	<b>1 400</b>				50
		1 020	1 125	1 220	1 305	<b>1 400</b>				40
	975	1 090	1 200	1 305	1 400	1 500				30
	1 180	1 330	1 460	1 585	1 700	1 820	2 100			10

## AC 70 T (continued)

### Technical data and load capacities

Tyre size	Service description LI/SS	Rims * (permitted)	Section width (mm)	Overall diameter (mm)	Loaded static radius (mm)	Rolling circumference (mm)	Speed radius index	
<b>380/70 R 20</b>	122 A8 (122 B)	<b>W 12</b> W 13 W 11	383 393 373	1 074	478	3 195	525	
<b>320/70 R 24</b>	116 A8 (116 B)	<b>W 10</b> W 11 W 9	320 330 310	1 095	505	3 276	525	
<b>360/70 R 24</b>	122 A8 (122 B)	<b>W 11</b> W 12 W 10	360 370 350	1 150	516	3 426	550	
<b>380/70 R 24</b>	125 A8 (125 B)	<b>W 12</b> W 13 W 11	387 397 377	1 187	538	3 508	575	
<b>420/70 R 24</b>	130 A8 (130 B)	<b>W 13</b> W 14 L W 12	433 443 423	1 260	563	3 715	600	
<b>380/70 R 28</b>	127 A8 (127 B)	<b>W 12</b> W 13 W 11	372 382 362	1 274	585	3 835	625	
<b>420/70 R 28</b>	133 A8 (133 B)	<b>W 13</b> W 14 L W 12	420 430 410	1 350	609	3 988	650	
<b>480/70 R 28</b>	140 A8 (140 B)	<b>W 15 L</b> W 16 L W 14 L	480 490 470	1 415	630	4 206	675	
<b>420/70 R 30</b>	134 A8 (134 B)	<b>W 13</b> W 14 L W 12	423 433 413	1 395	635	4 184	675	
<b>480/70 R 30</b>	141 A8 (141 B)	<b>W 15 L</b> W 16 L W 14 L	496 506 486	1 477	667	4 435	700	





AC 70 T

	Tyre load capacity (kg) at tyre pressure (bar)									Speed (km/h)
	0.6	0.8	1.0	1.2	1.4	1.6	2.0	2.4	3.0	
1 060 1 285	1 110 1 190 1 445	1 220 1 220 1 310 1 590	1 325 1 325 1 420 1 725	1 420 1 420 1 520 1 850	<b>1 500</b> <b>1 500</b> 1 605 1 950		2 250			50 40 30 10
885 1 075	930 995 1 210	1 020 1 020 1 095 1 330	1 110 1 110 1 185 1 440	1 190 1 190 1 270 1 545	<b>1 250</b> <b>1 250</b> 1 340 1 625		1 875			50 40 30 10
1 055 1 285	1 110 1 185 1 440	1 220 1 220 1 305 1 590	1 325 1 325 1 415 1 720	1 420 1 420 1 520 1 850	<b>1 500</b> <b>1 500</b> 1 605 1 950		2 250			50 40 30 10
1 150 1 395	1 205 1 290 1 570	1 330 1 330 1 420 1 725	1 440 1 440 1 540 1 870	1 540 1 540 1 650 2 010	<b>1 650</b> <b>1 650</b> 1 765 2 145		2 475			50 40 30 10
1 340 1 630	1 410 1 505 1 830	1 550 1 550 1 660 2 015	1 680 1 680 1 800 2 180	1 800 1 800 1 930 2 340	<b>1 900</b> <b>1 900</b> 2 030 2 470		2 850			50 40 30 10
1 235 1 500	1 300 1 390 1 690	1 430 1 430 1 530 1 855	1 550 1 550 1 660 2 010	1 660 1 660 1 775 2 160	<b>1 750</b> <b>1 750</b> 1 875 2 275		2 625			50 40 30 10
1 440 1 750	1 510 1 620 1 965	1 660 1 660 1 780 2 160	1 800 1 800 1 930 2 345	1 930 1 930 2 070 2 515	<b>2 060</b> <b>2 060</b> 2 200 2 680		3 090			50 40 30 10
1 770 2 150	1 855 1 985 2 410	2 040 2 040 2 185 2 655	2 215 2 215 2 370 2 880	2 375 2 375 2 540 3 090	<b>2 500</b> <b>2 500</b> 2 680 3 250		3 750			50 40 30 10
1 490 1 810	1 560 1 670 2 030	1 720 1 720 1 840 2 235	1 865 1 865 1 995 2 420	2 000 2 000 2 140 2 600	<b>2 120</b> <b>2 120</b> 2 270 2 760		3 180			50 40 30 10
1 820 2 220	1 880 2 010 2 450	2 060 2 060 2 200 2 680	2 240 2 240 2 400 2 910	2 420 2 420 2 590 3 150	<b>2 575</b> <b>2 575</b> 2 760 3 350		3 860			50 40 30 10

## AC 70 T (continued)

### Technical data and load capacities

Tyre size	Service description LI/SS	Rims * (permitted)	Section width (mm)	Overall diameter (mm)	Loaded static radius (mm)	Rolling circumference (mm)	Speed radius index
<b>480/70 R 34</b>	143 A8 (143 B)	<b>W 15 L</b> W 16 L W 14 L	490 500 480	1 575	710	4 686	750
<b>520/70 R 34</b>	148 A8 (148 B)	<b>W 16 L</b> W 18 L W 15 L	523 543 513	1 644	734	4 927	775
<b>480/70 R 38</b>	145 A8 (145 B)	<b>W 15 L</b> W 16 L W 14 L	487 497 477	1 687	767	5 065	800
<b>520/70 R 38</b>	150 A8 (150 B)	<b>W 16 L</b> W 18 L W 15 L	517 537 507	1 752	788	5 187	825
<b>580/70 R 38</b>	155 A8 (155 B)	<b>W 18 L</b>	570	1 829	819	5 442	875

\* Further admissible rims on request

Load values for 0.6 bar are for calculating dual and triple load values only.

30 km/h (up to 40 km/h) load values also apply for low-speed high-torque field work.

For plowing with single driven tyres in the furrow, a minimum inflation pressure of 0.8 bar is required.

For intensive road transport at 50/40/30 km/h the pressure must be increased by 0.4 bar. Maximum inflation pressure should never be exceeded.

All load values are valid for ground slopes up to and including 20% (11°). When operating on slopes greater than 20%, please, contact the producer.

Tubeless tyres – may be used with a tube.



AC 70 T

	Tyre load capacity (kg) at tyre pressure (bar)									Speed (km/h)
	0.6	0.8	1.0	1.2	1.4	1.6	2.0	2.4	3.0	
1 935 2 350	2 030 2 170 2 640	2 235 2 235 2 390 2 905	2 425 2 425 2 595 3 150	2 600 2 600 2 780 3 380	<b>2 725</b> <b>2 725</b> 2 915 3 545		4 090			50 40 30 10
2 185 2 655	2 295 2 455 2 980	2 525 2 525 2 700 3 285	2 740 2 740 2 930 3 560	2 935 2 935 3 140 3 820	<b>3 150</b> <b>3 150</b> 3 370 4 095		4 725			50 40 30 10
2 045 2 480	2 145 2 290 2 790	2 360 2 360 2 525 3 070	2 560 2 560 2 740 3 330	2 745 2 745 2 935 3 570	<b>2 900</b> <b>2 900</b> 3 100 3 770		4 350			50 40 30 10
2 300 2 800	2 380 2 550 3 090	2 600 2 600 2 780 3 380	2 830 2 830 3 030 3 680	3 060 3 060 3 270 3 980	<b>3 350</b> <b>3 350</b> 3 590 4 360		5 030			50 40 30 10
2 720 3 310	2 855 3 060 3 715	3 145 3 145 3 365 4 090	3 410 3 410 3 650 4 435	3 655 3 655 3 915 4 755	<b>3 875</b> <b>3 875</b> 4 145 5 040		5 815			50 40 30 10

kW	22	44	66	88	110	132	150	162	184	>220
hp	30	60	90	120	150	180	200	220	250	>300



## AC 70 G



# AC 70 G

## Wide grassland tyre with optimum road characteristics



The large, wide lug areas **protect ground and plants**.



**Stable, safe and comfortable running on the road**, thanks to a wide tread area and large lug overlap in the tread centre.



**Economical** thanks to low wear.



Large, wide lug areas mean quiet running on the road and gentle driving over grassland.

- Conventional profile design
- AC 70 G Tread pattern



# AC 70 G

## Technical data and load capacities

Tyre size	Service description LI/SS	Rims * (permitted)	Section width (mm)	Overall diameter (mm)	Loaded static radius (mm)	Rolling circumference (mm)	Speed radius index
<b>380/70 R 24</b>	125 A8 (125 B)	<b>W 12</b> W 13 W 11	385 395 375	1 190	540	3 524	575
<b>420/70 R 24</b>	130 A8 (130 B)	<b>W 13</b> W 14 L W 12	435 445 425	1 248	561	3 708	600
<b>480/70 R 24</b>	138 A8 (138 B)	<b>W 15 L</b> W 16 L W 14 L	483 493 473	1 313	582	3 908	625
<b>420/70 R 28</b>	133 A8 (133 B)	<b>W 13</b> W 14 L W 12	425 435 415	1 348	604	4 027	650
<b>480/70 R 30</b>	141 A8 (141 B)	<b>W 15 L</b> W 16 L W 14 L	485 495 475	1 462	653	4 345	700
<b>480/70 R 34</b>	143 A8 (143 B)	<b>W 15 L</b> W 16 L W 14 L	486 496 476	1 580	716	4 711	750
<b>520/70 R 34</b>	148 A8 (148 B)	<b>W 16 L</b> W 18 L W 15 L	539 559 529	1 649	740	4 930	775
<b>520/70 R 38</b>	150 A8 (150 B)	<b>W 16 L</b> W 18 L W 15 L	530 550 520	1 747	782	5 230	825

\* Further admissible rims on request

Load values for 0.6 bar are for calculating dual and triple load values only.

30 km/h (up to 40 km/h) load values also apply for low-speed high-torque field work.

For plowing with single driven tyres in the furrow, a minimum inflation pressure of 0.8 bar is required.

For intensive road transport at 50/40/30 km/h the pressure must be increased by 0.4 bar. Maximum inflation pressure should never be exceeded.

All load values are valid for ground slopes up to and including 20% (11°). When operating on slopes greater than 20%, please, contact the producer.

Tubeless tyres – may be used with a tube.



AC 70 G

	Tyre load capacity (kg) at tyre pressure (bar)							Speed (km/h)
	0.6	0.8	1.0	1.2	1.4	1.6	2.0	
			1 325	1 440	1 540	<b>1 650</b>		50
		1 205	1 325	1 440	1 540	<b>1 650</b>		40
1 150		1 290	1 420	1 540	1 650	1 770		30
1 400		1 570	1 725	1 870	2 005	2 145	2 475	10
			1 550	1 680	1 800	<b>1 900</b>		50
		1 405	1 550	1 680	1 800	<b>1 900</b>		40
1 340		1 505	1 660	1 800	1 930	2 035		30
1 630		1 830	2 015	2 185	2 310	2 470	2 850	10
			1 905	2 065	2 215	<b>2 360</b>		50
		1 730	1 905	2 065	2 215	<b>2 360</b>		40
1 650		1 855	2 040	2 215	2 375	2 525		30
2 005		2 250	2 480	2 690	2 885	3 070	3 540	10
			1 660	1 805	1 930	<b>2 060</b>		50
		1 510	1 660	1 805	1 930	<b>2 060</b>		40
1 440		1 615	1 780	1 930	2 070	2 205		30
1 750		1 965	2 160	2 345	2 515	2 680	3 090	10
			2 105	2 285	2 450	<b>2 575</b>		50
		1 915	2 105	2 285	2 450	<b>2 575</b>		40
1 825		2 050	2 255	2 445	2 620	2 755		30
2 215		2 490	2 740	2 970	3 185	3 350	3 865	10
			2 235	2 425	2 600	<b>2 725</b>		50
		2 030	2 235	2 425	2 600	<b>2 725</b>		40
1 935		2 170	2 390	2 595	2 780	2 915		30
2 350		2 640	2 905	3 150	3 380	3 545	4 090	10
			2 525	2 740	2 935	<b>3 150</b>		50
		2 290	2 525	2 740	2 935	<b>3 150</b>		40
2 185		2 455	2 700	2 930	3 140	3 370		30
2 655		2 985	3 285	3 560	3 820	4 095	4 725	10
			2 660	2 885	3 095	<b>3 350</b>		50
		2 420	2 660	2 885	3 095	<b>3 350</b>		40
2 305		2 590	2 850	3 090	3 315	3 585		30
2 800		3 145	3 460	3 755	4 025	4 355	5 025	10

Tractor Radial Tyres | AC 85

kW	22	44	66	88	110	132	150	162	184	>220
hp	30	60	90	120	150	180	200	220	250	>300



## AC 85





# AC 85

Modern design delivers outstanding performance, traction, durability, and long tyre life



**Outstanding long tyre life** thanks to the use of a wear-resistant tread compound.



**Durable radial tyre with balanced characteristics** for a wide range of applications both in the field and on the road.



Large contact patch enhances **traction**.



# AC 85

## Technical data and load capacities

Tyre size	Service description LI/SS	Rims * (permitted)	Section width (mm)	Overall diameter (mm)	Loaded static radius (mm)	Rolling circumference (mm)	Speed radius index
<b>280/85 R 20</b> (11.2 R 20)	112 A8 (112 B)	<b>W 10</b> W 9	299 289	981	444	2 934	475
<b>280/85 R 24</b> (11.2 R 24)	115 A8 (115 B)	<b>W 10</b> W 9	296 286	1 090	497	3 267	525
<b>320/85 R 24</b> (12.4 R 24)	122 A8 (122 B)	<b>W 11</b> W 10 W 9	343 333 323	1 158	530	3 484	550
<b>340/85 R 24</b> (13.6 R 24)	125 A8 (125 B)	<b>W 12</b> W 11	372 362	1 189	536	3 552	575
<b>380/85 R 24</b> (14.9 R 24)	131 A8 (131 B)	<b>W 12</b> W 13 W 11	402 412 392	1 258	563	3 745	600
<b>420/85 R 24</b> (16.9 R 24)	137 A8 (137 B)	<b>W 15</b> W 14 W 13	475 465 455	1 320	591	3 930	625
<b>280/85 R 28</b> (11.2 R 28)	118 A8 (118 B)	<b>W 10</b> W 9	298 288	1 190	551	3 582	575
<b>320/85 R 28</b> (12.4 R 28)	124 A8 (124 B)	<b>W 11</b> W 10 W 9	329 319 309	1 259	578	3 793	600
<b>340/85 R 28</b> (13.6 R 28)	127 A8 (127 B)	<b>W 12</b> W 11	367 357	1 299	587	3 885	625
<b>380/85 R 28</b> (14.9 R 28)	133 A8 (133 B)	<b>W 12</b> W 13 W 11	401 411 391	1 362	608	4 050	650



AC 85

	Tyre load capacity (kg) at tyre pressure (bar)									Speed (km/h)
	0.6	0.8	1.0	1.2	1.4	1.6	2.0	2.4	3.0	
			900	980	1 050	<b>1 120</b>				50
		820	900	980	1 050	<b>1 120</b>				40
	780	880	970	1 050	1 125	1 200				30
	950	1 070	1 175	1 275	1 365	1 455	1 680			10
			980	1 070	1 140	<b>1 215</b>				50
		890	980	1 070	1 140	<b>1 215</b>				40
	850	960	1 050	1 140	1 220	1 300				30
	1 030	1 160	1 280	1 390	1 490	1 580	1 825			10
			1 205	1 305	1 400	<b>1 500</b>				50
		1 095	1 205	1 305	1 400	<b>1 500</b>				40
	1 045	1 175	1 290	1 400	1 500	1 605				30
	1 270	1 425	1 570	1 700	1 825	1 950	2 250			10
			1 325	1 435	1 540	<b>1 650</b>				50
		1 205	1 325	1 435	1 540	<b>1 650</b>				40
	1 145	1 290	1 420	1 535	1 650	1 765				30
	1 395	1 565	1 720	1 870	2 005	2 145	2 475			10
			1 575	1 710	1 830	<b>1 950</b>				50
		1 430	1 575	1 710	1 830	<b>1 950</b>				40
	1 365	1 530	1 685	1 830	1 960	2 090				30
	1 660	1 860	2 050	2 220	2 380	2 535	2 925			10
			1 845	2 000	2 145	<b>2 300</b>				50
		1 675	1 845	2 000	2 145	<b>2 300</b>				40
	1 595	1 795	1 970	2 140	2 295	2 460				30
	1 940	2 175	2 395	2 600	2 790	2 990	3 450			10
			1 060	1 150	1 235	<b>1 320</b>				50
		965	1 060	1 150	1 235	<b>1 320</b>				40
	920	1 030	1 135	1 230	1 320	1 410				30
	1 120	1 255	1 380	1 495	1 605	1 715	1 980			10
			1 295	1 405	1 510	<b>1 600</b>				50
		1 180	1 295	1 405	1 510	<b>1 600</b>				40
	1 125	1 260	1 385	1 505	1 615	1 710				30
	1 365	1 530	1 685	1 830	1 960	2 080	2 400			10
			1 425	1 540	1 655	<b>1 750</b>				50
		1 295	1 425	1 540	1 655	<b>1 750</b>				40
	1 230	1 380	1 520	1 650	1 770	1 875				30
	1 500	1 680	1 850	2 005	2 150	2 275	2 625			10
			1 690	1 830	1 965	<b>2 060</b>				50
		1 535	1 690	1 830	1 965	<b>2 060</b>				40
	1 460	1 640	1 800	1 960	2 100	2 205				30
	1 775	1 995	2 195	2 380	2 550	2 680	3 090			10

## AC 85 (continued)

### Technical data and load capacities

Tyre size	Service description LI/SS	Rims * (permitted)	Section width (mm)	Overall diameter (mm)	Loaded static radius (mm)	Rolling circumference (mm)	Speed radius index	
<b>420/85 R 28</b> (16.9 R 28)	139 A8 (139 B)	<b>W 15</b> W 14 W 13	459 449 439	1 431	641	4 262	675	
<b>380/85 R 30</b> (14.9 R 30)	135 A8 (135 B)	<b>W 12</b> W 13 W 11	398 408 388	1 427	641	4 255	675	
<b>420/85 R 30</b> (16.9 R 30)	140 A8 (140 B)	<b>W 15</b> W 14 W 13	472 462 452	1 478	666	4 414	700	
<b>420/90 R 30</b>	147 A8 (147 B)	<b>W 13</b> W 14	434 444	1 529	681	4 520	725	
<b>460/85 R 30</b> (18.4 R 30)	145 A8 (145 B)	<b>W 16</b> W 15 W 14	516 506 496	1 546	697	4 618	725	
<b>380/85 R 34</b> (14.9 R 34)	146 A8 (146 B)	<b>W 12</b> W 13 W 11	401 411 391	1 538	699	4 577	725	
<b>420/85 R 34</b> (16.9 R 34)	142 A8 (142 B)	<b>W 15</b> W 14 W 13	471 461 451	1 598	724	4 761	750	
<b>420/85 R 34</b> (16.9 R 34)	147 A8 (147 B)	<b>W 15</b> W 14 W 13	469 459 449	1 593	722	4 755	750	
<b>460/85 R 34</b> (18.4 R 34)	147 A8 (147 B)	<b>W 16</b> W 15 W 14	518 508 498	1 676	756	4 982	775	
<b>340/85 R 38</b> (13.6 R 38)	133 A8 (133 B)	<b>W 12</b> W 11	365 355	1 562	719	4 685	750	

AC 85



	Tyre load capacity (kg) at tyre pressure (bar)									Speed (km/h)
	0.6	0.8	1.0	1.2	1.4	1.6	2.0	2.4	3.0	
			1 970	2 135	2 290	<b>2 430</b>				50
		1 790	1 970	2 135	2 290	<b>2 430</b>				40
	1 705	1 915	2 110	2 290	2 450	2 600				30
	2 070	2 325	2 560	2 780	2 980	3 160	3 645			10
			1 740	1 890	2 025	<b>2 180</b>				50
		1 585	1 740	1 890	2 025	<b>2 180</b>				40
	1 510	1 695	1 865	2 020	2 170	2 335				30
	1 835	2 060	2 265	2 460	2 635	2 835	3 270			10
			2 030	2 205	2 365	<b>2 500</b>				50
		1 845	2 030	2 205	2 365	<b>2 500</b>				40
	1 760	1 975	2 175	2 360	2 530	2 675				30
	2 140	2 400	2 640	2 865	3 075	3 250	3 750			10
			1 920	2 160	2 405	2 650	2 895			50
		1 680	1 920	2 160	2 405	2 650	2 895	<b>3 075</b>		40
	1 540	1 800	2 055	2 315	2 575	2 835	3 095	3 290		30
	1 875	2 185	2 500	2 810	3 125	3 445	3 760	4 000	4 615	10
			2 340	2 540	2 720	<b>2 900</b>				50
		2 130	2 340	2 540	2 720	<b>2 900</b>				40
	2 030	2 280	2 510	2 720	2 910	3 100				30
	2 460	2 760	3 040	3 300	3 540	3 770	4 350			10
			1 680	2 005	2 150	2 290	2 535			50
		1 680	1 850	2 005	2 150	2 290	2 535	<b>3 000</b>		40
	1 600	1 800	1 980	2 145	2 300	2 450	2 710	3 210		30
	1 945	2 185	2 405	2 610	2 795	2 970	3 295	3 900	4 500	10
			2 155	2 335	2 505	<b>2 650</b>				50
		1 955	2 155	2 335	2 505	<b>2 650</b>				40
	1 865	2 095	2 305	2 500	2 680	2 835				30
	2 265	2 545	2 800	3 035	3 255	3 445	3 975			10
			2 155	2 335	2 505	2 650	2 905			50
		1 955	2 155	2 335	2 505	2 650	2 905	<b>3 075</b>		40
	1 865	2 095	2 305	2 500	2 680	2 835	3 110	3 290		30
	2 265	2 545	2 800	3 035	3 255	3 445	3 775	4 000	4 350	10
			2 475	2 685	2 880	<b>3 075</b>				50
		2 250	2 475	2 685	2 880	<b>3 075</b>				40
	2 145	2 405	2 650	2 875	3 080	3 290				30
	2 605	2 925	3 220	3 490	3 745	4 000	4 615			10
			1 655	1 795	1 925	<b>2 060</b>				50
		1 500	1 655	1 795	1 925	<b>2 060</b>				40
	1 430	1 605	1 770	1 920	2 060	2 205				30
	1 740	1 955	2 150	2 335	2 500	2 680	3 090			10

## AC 85 (continued)

### Technical data and load capacities

Tyre size	Service description LI/SS	Rims * (permitted)	Section width (mm)	Overall diameter (mm)	Loaded static radius (mm)	Rolling circumference (mm)	Speed radius index	
<b>380/80 R 38</b> (14.9 R 38)	142 A8 (142 B)	<b>W 12</b> W 11 W 13	380 370 390	1 590	730	4 790	750	
<b>380/95 R 38</b>	147 D (150 A8)	<b>W 12</b> W 11 W 13	380 370 390	1 680	770	5 050	800	
<b>15.5 R 38<sup>1)</sup></b>	134 A8 (134 B)	<b>W 14</b>	400	1 570	723	4 712	750	
<b>420/85 R 38</b> (16.9 R 38)	144 A8 (144 B)	<b>W 15</b> W 14 W 13	469 459 449	1 696	772	5 088	800	
<b>460/85 R 38</b> (18.4 R 38)	149 A8 (149 B)	<b>W 16</b> W 15 W 14	508 498 488	1 768	805	5 280	825	
<b>520/85 R 38</b> (20.8 R 38)	155 A8 (155 B)	<b>W 16</b> W 18	545 565	1 857	827	5 515	875	
<b>480/80 R 42</b> (18.4 R 42)	151 A8 (151 B)	<b>W 16</b> W 15 W 14	513 503 495	1 850	835	5 540	875	
<b>520/85 R 42</b> (20.8 R 42)	162 A8 (162 B)	<b>W 16</b> W 18	537 557	1 966	896	5 878	925	
<b>480/80 R 46</b> (18.4 R 46)	158 A8 (158 B)	<b>W 16</b> W 15 W 14	507 497 487	1 960	896	5 886	925	
<b>520/85 R 46</b> (20.8 R 46)	158 A8 (158 B)	<b>W 16</b> W 18	545 565	2 043	930	6 131	975	



	Tyre load capacity (kg) at tyre pressure (bar)									Speed (km/h)
	0.6	0.8	1.0	1.2	1.4	1.6	2.0	2.4	3.0	
1 455 1 770	1 545 1 655 2 010	1 720 1 720 1 840 2 235	1 880 1 880 2 010 2 440	2 090 2 090 2 235 2 715	2 300 2 300 2 460 2 990	2 505 2 505 2 680 3 255	<b>2 650</b> <b>2 650</b> 2 835 3 445		3 900	50 40 30 10
	1 875 1 955 2 050 2 495	2 085 2 170 2 495 2 775	2 170 2 280 2 375 2 495 3 035	2 410 2 530 2 640 2 770 3 375	2 650 2 785 2 900 3 050 3 710	2 900 3 045 3 175 3 335 4 060	<b>3 075</b> 3 230 <b>3 350</b> 3 535 4 305		4 615	65 50 40 30 10
1 240 1 500	1 350 1 440 1 750	1 540 1 540 1 650 2 010	1 740 1 740 1 860 2 260	1 930 1 930 2 060 2 510	<b>2 120</b> <b>2 120</b> 2 270 2 760		3 180			50 40 30 10
1 965 2 390	2 065 2 210 2 685	2 270 2 270 2 430 2 955	2 465 2 465 2 635 3 205	2 640 2 640 2 830 3 435	<b>2 800</b> <b>2 800</b> 3 000 3 640		4 200			50 40 30 10
2 255 2 745	2 370 2 535 3 080	2 605 2 605 2 790 3 390	2 830 2 830 3 030 3 680	3 030 3 030 3 245 3 945	<b>3 250</b> <b>3 250</b> 3 480 4 225		4 875			50 40 30 10
2 725 3 310	2 860 3 060 3 720	3 150 3 150 3 370 4 090	3 415 3 415 3 655 4 440	3 660 3 660 3 920 4 760	<b>3 875</b> <b>3 875</b> 4 145 5 040		5 815			50 40 30 10
2 170 2 840	2 305 2 465 3 230	2 565 2 565 2 745 3 590	2 805 2 805 3 000 3 925	3 125 3 125 3 345 4 375	<b>3 450</b> <b>3 450</b> 3 690 4 830		5 175			50 40 30 10
2 860 3 470	2 995 3 205 3 895	3 300 3 300 3 530 4 285	3 575 3 575 3 825 4 650	3 840 3 840 4 100 4 990	4 075 4 075 4 360 5 300	4 520 4 520 4 835 5 875	<b>4 750</b> <b>4 750</b> 5 085 6 175		7 125	50 40 30 10
2 270 2 760	2 410 2 580 3 135	2 685 2 685 2 870 3 485	2 935 2 935 3 140 3 815	3 245 3 245 3 470 4 215	3 550 3 550 3 800 4 615	3 960 3 960 4 240 5 545	<b>4 250</b> <b>4 250</b> 4 550 5 950		6 300	50 40 30 10
2 785 3 625	3 130 3 350 4 070	3 445 3 445 3 685 4 480	3 735 3 735 4 000 4 855	4 005 4 005 4 290 5 210	<b>4 250</b> <b>4 250</b> 4 550 5 525		6 375			50 40 30 10

## AC 85 (continued)

### Technical data and load capacities

Tyre size	Service description LI/SS	Rims * (permitted)	Section width (mm)	Overall diameter (mm)	Loaded static radius (mm)	Rolling circumference (mm)	Speed radius index	
<b>380/90 R 50</b> (14.9 R 50)	151 A8 (151 B)	<b>W 12</b> W 13 W 11	380 390 370	1 949	888	5 850	925	
<b>480/80 R 50</b>	159 A8 (159 B)	<b>W 16</b> W 15 W 14	495 485 475	2 065	945	6 210	975	
<b>480/95 R 50</b>	164 D (167 A8)	<b>W 16</b> W 15 W 14	498 488 478	2 135	968	6 450	1075	

\* Further admissible rims on request

<sup>1)</sup> Tread pattern AC 51 +

Load values for 0.6 bar are for calculating dual and triple load values only.

30 km/h (up to 40 km/h) load values also apply for low-speed high-torque field work.

For plowing with single driven tyres in the furrow, a minimum inflation pressure of 0.8 bar is required.

For intensive road transport at 65/50/40/30 km/h the pressure must be increased by 0.4 bar. Maximum inflation pressure should never be exceeded.

All load values are valid for ground slopes up to and including 20% (11°). When operating on slopes greater than 20%, please, contact the producer.

Tubeless tyres – may be used with a tube.





AC 85

	Tyre load capacity (kg) at tyre pressure (bar)									Speed (km/h)
	0.6	0.8	1.0	1.2	1.4	1.6	2.0	2.4	3.0	
			2 180	2 385	2 640	2 900	3 215	<b>3 450</b>		50
		1 960	2 180	2 385	2 640	2 900	3 215	<b>3 450</b>		40
	1 845	2 095	2 330	2 550	2 825	3 105	3 440	3 690		30
	2 415	2 745	3 050	3 335	3 700	4 060	4 505	4 830	5 175	10
			2 800	3 060	3 405	3 750	4 105	<b>4 375</b>		50
		2 515	2 800	3 060	3 405	3 750	4 105	<b>4 375</b>		40
	2 370	2 695	2 995	3 275	3 645	3 830	4 395	4 680		30
	3 100	3 525	3 920	4 285	4 765	5 010	5 750	6 125	6 565	10
			3 220	3 530	3 950	4 375	4 715	<b>5 000</b>		65
		3 050	3 390	3 710	4 150	4 590	4 955	<b>5 250</b>		50
		3 180	3 535	3 865	4 325	4 750	5 165	5 450		40
		3 340	3 715	4 060	4 545	5 030	5 425	5 750		30
		4 065	4 520	4 945	4 860	6 120	6 605	7 000	7 500	10



## AC 85

LOAD CAPACITY	██████████
TRACTION	██████████
CROP PROTECTION	██████████
HANDLING ON ROAD	██████████
COST EFFICIENCY	██████████



## AC 90

LOAD CAPACITY	██████████
TRACTION	██████████
CROP PROTECTION	██████████
HANDLING ON ROAD	██████████
COST EFFICIENCY	██████████

# AC 85 / AC 90 Row Crop

## Narrow tyres developed specially for row cultivation



**Reduced tyre width** eases driving between plants without causing damage, contributing to higher yields. Rounded shoulders, lugs and tyre height also protect crops.



**Cost-efficient** thanks to durable construction that offers high load capacity and transport speeds up to 65 km/h.



**Deep lugs** provide **excellent traction**, better directional stability and a high level of control.



**Good self-cleaning properties** help keep the tread pattern free of mud, resulting in less slip, even in difficult conditions.

### AC 85 / AC 90 vs. standard size tyres

Narrow Row Crop tyres were specially developed for driving between rows without damaging the seeds, roots and plants. They are suitable for line weeding, crop cultivation, fertilising, spraying and other agricultural activities.

#### Reduced tyre width



Tractor fitted with Mitas narrow tyres



Tractor fitted with wide tread-width tyres

#### Rounded lugs

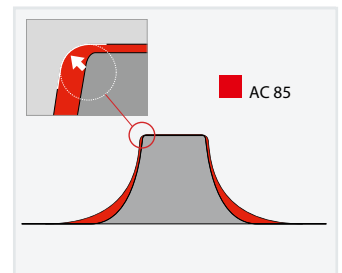

## Row Crop

### Technical data and load capacities

Tyre size	Tread pattern	Service description LI/SS	Rims * (permitted)	Section width (mm)	Overall diameter (mm)	Loaded static radius (mm)	Rolling circumference (mm)	Speed radius index	
<b>270/80 R 32</b> (repl. 9.5 R 32)	AC 90	131 A8 (128 B)	<b>W 9</b> W 10 W 8	270 280 260	1 225	563	3 690	600	
<b>270/95 R 32</b>	AC 85	136 A8 (136 B)	<b>W 9</b> W 10 W 8	290 300 280	1 349	619	4 054	625	
<b>320/85 R 32</b> (repl. 12.4 R 32)	AC 85	142 A8 (142 B)	<b>W 10</b> W 11 W 9	309 319 299	1 365	625	4 035	650	
<b>320/90 R 32</b>	AC 85	134 A8 (134 B)	<b>W 10</b> W 11 W 9	331 341 321	1 391	638	4 190	675	
<b>320/85 R 34</b> (repl. 12.4 R 34)	AC 85	133 A8 (133 B)	<b>W 10</b> W 11 W 9	326 336 316	1 430	650	4 285	675	
<b>270/80 R 36</b> (repl. 9.5 R 36)	AC 90	134 A8 (131 B)	<b>W 9</b> W 10 W 8	270 280 260	1 345	623	4 015	650	
<b>13.6 R 36</b>	AC 90	127 A8 (124 B)	<b>W 12</b> W 11	360 350	1 499	692	4 492	725	

AC 85



AC 90



	Tyre load capacity (kg) at tyre pressure (bar)									Speed (km/h)
	1.2	1.6	2.0	2.4	2.8	3.2	3.6	4.0	4.4	
		1 150	1 265	1 345	1 470	1 585	1 685	<b>1 800</b>		50
	1 035	1 265	1 390	1 480	1 620	1 740	1 855	<b>1 950</b>		40
	1 110	1 355	1 485	1 585	1 730	1 865	1 985	2 085		30
	1 275	1 555	1 710	1 820	1 990	2 145	2 280	2 400		20
	1 450	1 770	1 945	2 070	2 265	2 440	2 595	2 730	2 845	10
	1 555	1 900	2 085	2 220	2 425	2 615	2 780	2 925	3 050	10 Cyclic
		1 450	1 600	1 700	1 865	2 010	2 145	<b>2 240</b>		50
	1 190	1 450	1 600	1 700	1 865	2 010	2 145	<b>2 240</b>		40
	1 275	1 550	1 710	1 820	1 995	2 155	2 295	2 395		30
	1 465	1 785	1 965	2 090	2 295	2 475	2 640	2 755		20
	1 670	2 030	2 235	2 380	2 610	2 815	3 005	3 135	3 310	10
	1 785	2 175	2 395	2 550	2 795	3 020	3 215	3 360	3 545	10 Cyclic
		1 710	1 880	2 000	2 190	2 360	2 515	<b>2 650</b>		50
	1 400	1 710	1 880	2 000	2 190	2 360	2 515	<b>2 650</b>		40
	1 500	1 830	2 010	2 140	2 345	2 530	2 690	2 835		30
	1 725	2 105	2 310	2 460	2 695	2 905	3 095	3 260		20
	1 960	2 395	2 630	2 800	3 065	3 305	3 520	3 710	3 875	10
	2 100	2 570	2 820	3 000	3 285	3 545	3 775	3 975	4 150	10 Cyclic
		1 795	1 990	<b>2 120</b>						50
	1 575	1 795	1 990	<b>2 120</b>						40
	1 690	1 920	2 130	2 270						30
	1 935	2 205	2 445	2 605	(3.0 bar)					20
	2 050	2 335	2 590	2 760	3 180					10
	2 195	2 500	2 770	2 955	3 400					10 Cyclic
		1 750	1 935	<b>2 060</b>						50
	1 445	1 750	1 935	<b>2 060</b>						40
	1 545	1 875	2 070	2 205						30
	1 775	2 155	2 380	2 535						20
	2 020	2 450	2 710	2 885	2 995					10
	2 165	2 625	2 905	3 090	3 205					10 Cyclic
		1 225	1 345	1 435	1 575	1 705	1 825	<b>1 950</b>		50
	1 105	1 350	1 480	1 575	1 730	1 875	2 005	<b>2 120</b>		40
	1 180	1 440	1 580	1 685	1 850	2 005	2 145	2 270		30
	1 355	1 660	1 820	1 940	2 130	2 305	2 465	2 610		20
	1 545	1 885	2 070	2 205	2 425	2 625	2 805	2 970	3 115	10
	1 655	2 020	2 220	2 365	2 595	2 810	3 005	3 180	3 335	10 Cyclic
	1 300	<b>1 600</b>								50
	1 430	1 750								40
	1 530	1 870								30
	1 760	2 150								20
	1 860	2 280	2 630							10
	1 990	2 440	2 830							10 Cyclic

## Row Crop (continued)

### Technical data and load capacities

Tyre size	Tread pattern	Service description LI/SS	Rims * (permitted)	Section width (mm)	Overall diameter (mm)	Loaded static radius (mm)	Rolling circumference (mm)	Speed radius index	
<b>320/85 R 38</b> (repl. 12.4 R 38)	AC 85	143 A8 (143 B)	<b>W 10</b> W 11 W 9	322 332 312	1 518	701	4 580	725	
<b>340/85 R 38</b> (repl. 13.6 R 38)	AC 85	148 A8 (148 B)	<b>W 11</b> W 12	355 365	1 562	719	4 685	750	
<b>300/85 R 42</b> (repl. 11.2 R 42)	AC 90	144 A8 (141 B)	<b>W 9</b> W 10 W 11	288 298 308	1 574	740	4 715	750	
<b>300/95 R 42</b> (repl. 12.4 R 42)	AC 90	147 A8 (144 B)	<b>W 9</b> W 10 W 11	296 306 316	1 617	753	4 904	775	
<b>320/90 R 42°</b>	AC 85	151 A8 (151 B)	<b>W 10</b> W 11 W 9	319 329 309	1 643	765	4 970	800	
<b>IF 320/90 R 42°</b>	AC 85	155 B	<b>W 11</b> W 10	323 313	1 643	750	4 930	800	
<b>320/95 R 46</b>	AC 85	152 A8 (152B)	<b>W 10</b> W 11 W 9	330 340 320	1 770	806	5 298	825	
<b>380/90 R 46</b> (repl. 14.9 R 46)	AC 85	149 A8 (149 B)	<b>W 12</b> W 13 W 11	392 402 382	1 844	846	5 542	875	



	Tyre load capacity (kg) at tyre pressure (bar)									Speed (km/h)
	1.2	1.6	2.0	2.4	2.8	3.2	3.6	4.0	4.4	
										50
1 530	1 850	2 050	2 180	2 395	2 585	<b>2 725</b>				40
1 635	1 850	2 050	2 180	2 395	2 585	<b>2 725</b>				30
1 880	1 980	2 195	2 335	2 560	2 765	2 915				20
2 140	2 275	2 520	2 680	2 945	3 175	3 350				10
2 445	2 590	2 870	3 050	3 350	3 715	3 815		4 065		10 Cyclic
	2 960	3 280	3 490	3 590	4 135	4 360		4 645		
		2 060	2 230	2 360	2 620	2 825	3 010	<b>3 150</b>		50
1 795	2 060	2 230	2 360	2 620	2 825	3 010	<b>3 150</b>			40
1 920	2 205	2 385	2 525	2 800	3 025	3 225	3 370			30
2 205	2 535	2 745	2 905	3 220	3 475	3 705	3 875			20
2 515	2 885	3 125	3 305	3 665	3 955	4 215	4 410		4 650	10
2 695	3 090	3 345	3 540	3 930	4 240	4 520	4 725		4 980	10 Cyclic
		1 630	1 790	1 905	2 090	2 260	2 410	<b>2 575</b>		50
1 465	1 790	1 965	2 095	2 300	2 485	2 650	<b>2 800</b>			40
1 570	1 920	2 105	2 240	2 460	2 655	2 835	2 995			30
1 805	2 205	2 420	2 575	2 825	3 055	3 260	3 445			20
2 055	2 510	2 755	2 935	3 215	3 470	3 695	3 920		4 105	10
2 200	2 690	2 950	3 145	3 445	3 725	3 975	4 200		4 395	10 Cyclic
		1 785	1 955	2 085	2 290	2 475	2 645	<b>2 800</b>		50
1 605	1 960	2 150	2 290	2 515	2 720	2 905	<b>3 075</b>			40
1 715	2 095	2 300	2 450	2 690	2 910	3 110	3 290			30
1 970	2 410	2 645	2 815	3 095	3 345	3 575	3 780			20
2 245	2 745	3 010	3 205	3 520	3 810	4 070	4 305		4 515	10
2 405	2 940	3 225	3 425	3 770	4 080	4 360	4 615		4 835	10 Cyclic
		2 060	2 240	2 430	2 650	2 900	3 075	3 250	<b>3 450</b>	50
1 700	2 060	2 240	2 430	2 650	2 900	3 075	3 250	<b>3 450</b>		40
1 820	2 205	2 395	2 600	2 835	3 100	3 290	3 480	3 690		30
2 090	2 535	2 755	2 990	3 260	3 570	3 780	4 000	4 245		20
2 380	2 885	3 135	3 400	3 710	4 060	4 305	4 550	4 830		10
2 550	3 090	3 360	3 645	3 975	4 350	4 615	4 875	5 175		10 Cyclic
		2 040	2 200	2 375	2 550	2 725	2 900	<b>3 075</b>		50
1 795	2 200	2 400	2 550	2 770	3 035	3 215	<b>3 410</b>			50 Dual
		2 240	2 485	2 650	2 895	3 125	3 330	<b>3 550</b>		50
1 850	2 240	2 485	2 650	2 895	3 125	3 330	<b>3 550</b>			40
1 980	2 395	2 655	2 825	3 100	3 345	3 565	3 800			30
2 275	2 755	3 055	3 260	3 560	3 845	4 095	4 365			20
2 405	2 910	3 475	3 700	4 055	4 375	4 660	4 970		5 140	10
2 775	3 360	3 720	3 965	4 340	4 685	4 995	5 325		5 505	10 Cyclic
		2 790	3 060	<b>3 250</b>						50
2 280	2 790	3 060	<b>3 250</b>							40
2 440	2 985	3 275	3 480							30
2 805	3 430	3 765	4 000	(3.0 bar)						20
3 195	3 905	4 285	4 550	4 875						10
3 425	4 185	4 590	4 875	5 200						10 Cyclic

## Row Crop (continued)

### Technical data and load capacities

Tyre size	Tread pattern	Service description LI/SS	Rims * (permitted)	Section width (mm)	Overall diameter (mm)	Loaded static radius (mm)	Rolling circumference (mm)	Speed radius index	
<b>380/90 R 46</b> (repl. 14.9 R 46)	AC 85	159 A8 (159 B)	<b>W 12</b> W 13 W 11	392 402 382	1 844	846	5 542	875	
<b>270/95 R 48</b> (repl. 11.2 R 48)	AC 90	144 A8 (141 B)	<b>W 9</b> W 10 W 8	277 287 267	1 737	810	5 220	825	
<b>340/90 R 48</b> (repl. 13.6 R 48)	AC 85	154 A8 (154 B)	<b>W 11</b> W 12	348 358	1 825	843	5 481	875	
<b>320/90 R 50</b>	AC 85	150 A8 (150 B)	<b>W 10</b> W 11 W 9	315 325 305	1 870	873	5 680	875	
<b>380/90 R 50</b> (repl. 14.9 R 50)	AC 85	160 A8 (160 B)	<b>W 12</b> W 13 W 11	380 390 370	1 949	888	5 850	925	
<b>320/90 R 54</b>	AC 85	151 A8 (151 B)	<b>W 10</b> W 11 W 9	315 325 305	1 948	917	5 940	925	
<b>380/90 R 54</b>	AC 85	152 A8 (152 B)	<b>W 12</b> W 13 W 11	380 390 370	2 056	945	6 200	975	





	Tyre load capacity (kg) at tyre pressure (bar)									Speed (km/h)
	1.2	1.6	2.0	2.4	2.8	3.2	3.6	4.0	4.4	
		2 790	3 060	3 250	3 580	3 870	4 135	<b>4 375</b>		50
2 280	2 790	3 060	3 250	3 580	3 870	4 135	4 135	<b>4 375</b>		40
2 440	2 985	3 275	3 480	3 830	4 145	4 425	4 425	4 680		30
2 805	3 430	3 765	4 000	4 405	4 760	5 090	5 380	5 380		20
3 195	3 905	4 285	4 550	5 010	5 420	5 790	6 125	6 125	6 420	10
3 425	4 185	4 590	4 875	5 370	5 810	6 205	6 565	6 565	6 880	10 Cyclic
	1 645	1 805	1 920	2 105	2 270	2 415	<b>2 575</b>			50
1 475	1 805	1 980	2 110	2 310	2 495	2 655	<b>2 800</b>			40
1 580	1 930	2 120	2 260	2 475	2 665	2 840	2 995			30
1 815	2 220	2 435	2 595	2 840	3 065	3 245	3 445			20
2 070	2 525	2 775	2 955	3 235	3 490	3 720	3 920		4 095	10
2 215	2 710	2 970	3 165	3 465	3 740	3 985	4 200		4 390	10 Cyclic
	2 430	2 645	2 800	3 100	3 345	3 565	<b>3 750</b>			50
1 980	2 430	2 645	2 800	3 100	3 345	3 565	<b>3 750</b>			40
2 120	2 600	2 830	2 995	3 315	3 580	3 815	4 015			30
2 435	2 990	3 250	3 445	3 810	4 115	4 385	4 615			20
2 575	3 160	3 435	3 640	4 030	4 350	4 635	4 875	5 110		10
2 970	3 645	3 965	4 200	4 650	5 015	5 345	5 625	5 895		10 Cyclic
	2 265	2 485	2 650	2 900	3 130	<b>3 350</b>				50
1 855	2 265	2 485	2 650	2 900	3 130	<b>3 350</b>				40
1 980	2 425	2 660	2 830	3 105	3 350	3 585				30
2 280	2 785	3 055	3 255	3 565	3 850	4 120				20
2 595	3 170	3 480	3 705	4 060	4 380	4 690	4 925			10
2 780	3 395	3 730	3 970	4 350	4 695	5 025	5 275			10 Cyclic
	2 900	3 215	3 450	3 730	4 025	4 290	<b>4 500</b>			50
2 385	2 900	3 215	3 450	3 730	4 025	4 290	<b>4 500</b>			40
2 550	3 105	3 440	3 690	3 990	4 305	4 590	4 815			30
2 930	3 565	3 955	4 245	4 590	4 950	5 275	5 535			20
3 335	4 060	4 505	4 830	5 220	5 635	6 005	6 300	6 620		10
3 575	4 350	4 825	5 175	5 595	6 040	6 435	6 750	7 095		10 Cyclic
	2 360	2 590	2 760	3 025	3 265	<b>3 450</b>				50
1 930	2 360	2 590	2 760	3 025	3 265	<b>3 450</b>				40
2 070	2 525	2 775	2 955	3 235	3 490	3 690				30
2 375	2 905	3 190	3 395	3 720	4 015	4 225				20
2 705	3 305	3 630	3 865	4 235	4 570	4 830	5 135			10
2 900	3 545	3 890	4 140	4 535	4 895	5 175	5 505			10 Cyclic
	2 485	3 000	3 330	<b>3 550</b>						50
2 485	3 000	3 330	<b>3 550</b>							40
2 655	3 210	3 565	3 800							30
3 055	3 690	4 095	4 365							20
3 225	3 900	4 330	4 615	4 800						10
3 725	4 500	4 995	5 325	5 535						10 Cyclic

## Row Crop (continued)

### Technical data and load capacities

Tyre size	Tread pattern	Service description LI/SS	Rims * (permitted)	Section width (mm)	Overall diameter (mm)	Loaded static radius (mm)	Rolling circumference (mm)	Speed radius index
<b>380/105 R 54</b>	AC 85	162 D (164 B)	<b>W 12</b> W 13 W 11	380 390 370	2 170	1 012	6 580	1025

\* Further admissible rims on request

° In preparation, please contact Mitas for availability

30 km/h (up to 40 km/h) load values also apply for low-speed high-torque field work.

For plowing with single driven tyres in the furrow, a minimum inflation pressure of 0.8 bar is required.

For intensive road transport at 50/40/30 km/h the pressure must be increased by 0.4 bar. Maximum inflation pressure should never be exceeded.

All load values are valid for ground slopes up to and including 20% (11°). When operating on slopes greater than 20%, please, contact the producer.

Load-pressure data for cyclic applications apply to low-torque transport operations at max. speeds of 10 km/h and for a max. distance of 800 meters before discharging the load and returning empty.

Tubeless tyres – may be used with a tube.

AC 85



AC 90



	Tyre load capacity (kg) at tyre pressure (bar)									Speed (km/h)
	1.2	1.6	2.0	2.4	2.8	3.2	3.6	4.0	4.4	
	2 800	3 450	3 750	4 000	4 375	<b>4 750</b>				65
	2 940	3 620	3 940	4 200	4 595	<b>5 000</b>				50
	3 070	3 780	4 105	4 380	4 790	5 200				40
	3 220	3 970	4 315	4 600	5 030	5 460				30
	3 920	4 830	5 250	5 600	6 125	6 650				10
	4 520	5 570	6 055	6 460	7 065	7 670				10 Cyclic



## HC 3000



# HC 3000

## New Very High Flexion (VF) harvester tyre for Cyclic Field Operation (CFO)



Less inflation pressure provides **excellent traction** efficiency.





**Higher load capacity** for higher haulage efficiency.



Larger footprint for **better ground protection** and **reduced soil compaction**.

### Mitas VF 710/70 R 42 CFO HC 3000

Lower Soil Compaction for sustainable farming.

Standard	710/70 R 42 179A8	VF 710/70 R 42 CFO	800/70 R 38 181A8
Inflation pressure (bar)	3.8	<b>2.8</b>	3.0
Footprint (%)	100	<b>136</b>	127
		 <b>+ 36%</b>	 <b>+ 27%</b>

Inflation Pressures and Footprints at 13 300 kg load/tyre at cyclic field conditions.

# HC 3000

## Technical data and load capacities

Tyre size	Service description LI/SS	Rims * (permitted)	Section width (mm)	Overall diameter (mm)	Loaded static radius (mm)	Rolling circumference (mm)	Speed radius index
<b>VF 580/80 R 34 CFO°</b>	178 B	<b>W 20</b> W 18 W 21	886 566 596	1 792	755	4 900	875
<b>VF 520/85 R 42 CFO</b>	177 B	<b>DW 18 L</b>	557	1 966	875	5 850	925
<b>VF 580/85 R 42 CFO</b>	183 B	<b>DW 20 B</b> DW 21 B	587 598	2 045	920	6 100	975
<b>VF 710/70 R 42 CFO</b>	190 B	<b>DW 23 B</b> DW 25 B	706 726	2 070	920	6 140	975

\* Further admissible rims on request

° In preparation, please contact Mitas for availability

Load values for 0.4 bar and 0.6 bar at 50 km/h are for calculating dual and triple load values only.

For plowing with single driven tyres in the furrow, a minimum inflation pressure of 0.8 bar is required.

For intensive road transport at 50/40/30 km/h the pressure must be increased by 0.4 bar. Maximum inflation pressure should never be exceeded.

All load values are valid for ground slopes up to and including 20% (11°). When operating on slopes greater than 20%, please, contact the producer.

Load-pressure data for cyclic applications apply to low-torque transport operations at max. speeds of 15 km/h and for a max. distance of 800 meters before discharging the load and returning empty.

By cyclic application (CFO) mean harvester's motion with full grain tank till its discharging.

CFO: Cyclic Field Operation

Tubeless tyres – may be used with a tube.



HC 3000

	Tyre load capacity (kg) at tyre pressure (bar)									Speed (km/h)
	0.6	0.8	1.0	1.2	1.6	2.0	2.4	2.8	3.2	
	2 815	3 750 3 300	4 250 3 740	4 800 4 225	5 800 5 105	6 300 5 545	6 900 6 070	<b>7 500</b> 6 600		0–50 0–50 Dual 0–15 CFO 0–15 CFO Dual
		3 800 4 455	5 065 5 050	5 740 5 700	7 830 6 890	8 505 7 485	9 315 8 195	10 125 8 910		
			3 650 4 930	4 180 5 645	5 800 5 105 7 830 6 890	6 150 5 410 8 305 7 305	6 700 5 895 9 045 7 960	<b>7 300</b> 6 425 9 855 8 670		0–50 0–50 Dual 0–15 CFO 0–15 CFO Dual
			4 320 5 830	5 400 7 290	6 700 5 895 9 045 7 960	7 400 6 510 9 990 8 790	8 100 7 130 10 935 9 625	<b>8 750</b> 7 700 11 815 10 395		0–50 0–50 Dual 0–15 CFO 0–15 CFO Dual
			4 980 6 720	5 600 7 560	7 750 6 820 10 465 9 205	8 350 7 350 11 275 9 920	9 000 7 920 12 150 10 690	9 850 8 670 13 300 11 700	<b>10 600</b> 9 330 14 310 12 595	0–50 0–50 Dual 0–15 CFO 0–15 CFO Dual

Harvester Radial Tyres



## SFT CHO





# CHO

Cyclic Harvesting Operation tyre.  
The most gentle ground handling  
tyre extending comfortably the  
harvesting time frame



Harvester tyre with **maximum cyclic axle load capacity**.



**Extremely low inflation pressure and more maximum load capacity** at the same time.



**Larger footprint** than standard harvester tyres guarantees gentler ground handling and extends the harvesting time frame.



Due to its **compact, narrow construction** the tyre fulfils all legal requirements (limited vehicle width).

Vehicle width decrease

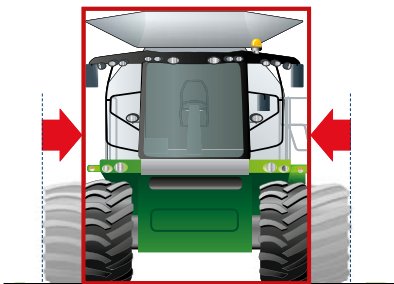

Mobility increase

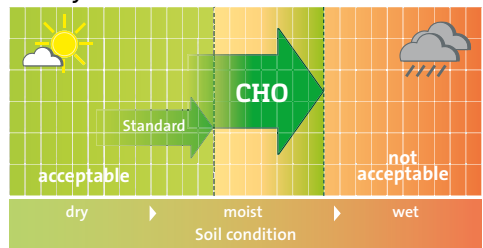

## Harvesting time frame

Extension of time frame for harvesting by reducing inflation pressure.

# Harvester CHO drive wheel

## Technical data and load capacities

Tyre size	Tread pattern	Service description LI/SS	Rims * (permitted)	Section width (mm)	Overall diameter (mm)	Loaded static radius (mm)	Rolling circumference (mm)	Speed radius index
<b>680/85 R 32 CHO</b>	AC 70 G	178 A8 (175 B)	<b>DW 20 B</b> DW 21 B DW 23 B	663 673 693	1 960	858	5 865	925
<b>800/70 R 32 CHO</b>	SFT	175 A8 (172 B)	<b>DW 25 B</b> DW 27 B	748 768	1 932	845	5 630	925
<b>900/60 R 32 CHO</b>	SFT	176 A8 (173 B)	<b>DW 27 B</b> DW 30 B	835 865	1 927	851	5 700	925
<b>900/70 R 32 CHO</b>	SFT	182 A8 (179 B)	<b>DW 27 B</b> DW 30 B	881 911	2 061	904	6 075	975
<b>900/70 R 32 CHO</b>	SFT	188 A8 (185 B)	<b>DW 27 B</b> DW 30 B	885 915	2 058	904	6 075	975
<b>680/80 R 38 CHO</b>	SFT	179 D (182 A8)	<b>DW 21 B</b> DW 20 B DW 23 B	650 640 670	2 053	895	6 070	975
<b>800/70 R 38 CHO</b>	SFT	178 D (181 A8)	<b>DW 25 B</b> DW 27 B	766 786	2 042	916	6 090	975

CHO



	Tyre load capacity (kg) at tyre pressure (bar)										Speed (km/h)
	0.6	0.8	1.0	1.2	1.4	1.6	2.0	2.4	2.8	3.2	
			3 865	4 230	4 635	5 000	5 515	6 000	6 435	<b>6 900</b>	50
		3 915	4 245	4 645	5 090	5 450	6 060	6 500	7 070	<b>7 500</b>	40
3 775	4 190	4 540	4 970	5 445	5 830	6 485	6 955	7 565	8 025	8 025	30
3 915	4 345	4 710	5 155	5 650	6 050	6 725	7 215	7 850	8 235	8 235	25
4 340	4 815	5 220	5 715	6 260	6 705	7 450	7 995	8 695	9 225	9 225	20
6 350	7 045	7 640	8 365	9 165	9 810	10 905	11 700	12 725	13 500	13 500	10 CHO
			4 180	4 575	5 010	5 450	5 965	<b>6 300</b>			50
		4 235	4 590	5 025	5 505	6 000	6 555	<b>6 900</b>			40
4 085	4 530	4 915	5 380	5 895	6 420	7 015	7 385	7 385			30
4 235	4 700	5 095	5 580	6 115	6 600	7 275	7 660	7 660			25
4 695	5 210	5 650	6 180	6 775	7 380	8 060	8 485	8 485			20
	7 625	8 265	9 045	9 915	10 800	11 800	12 500				10 CHO
			4 250	4 650	5 020	5 300	5 950	<b>6 500</b>			50
		4 315	4 670	5 110	5 515	5 800	6 535	<b>7 100</b>			40
4 165	4 615	5 000	5 465	5 900	6 205	6 995	7 595	7 595			30
4 320	4 790	5 185	5 670	6 120	6 440	7 255	7 880	7 880			25
4 790	5 305	5 745	6 285	6 785	7 135	8 040	8 735	8 735			20
	7 765	8 410	9 195	9 925	10 440	11 765	12 780				10 CHO
		4 660	5 055	5 530	6 060	6 700	7 215	<b>7 750</b>			50
		5 120	5 555	6 080	6 660	7 300	7 925	<b>8 500</b>			40
4 940	5 480	5 945	6 505	7 125	7 810	8 480	9 095	9 095			30
5 125	5 685	6 165	6 750	7 395	8 105	8 800	9 435	9 435			25
5 675	6 300	6 830	7 475	8 195	8 980	9 750	10 455	10 455			20
	9 220	9 995	10 940	11 990	13 140	14 270	15 300				10 CHO
			5 055	5 530	6 060	6 700	7 215	7 750	8 415	<b>9 250</b>	50
		5 120	5 555	6 080	6 660	7 300	7 925	8 500	9 250	<b>10 000</b>	40
4 940	5 480	5 945	6 505	7 125	7 810	8 480	9 095	9 895	10 700	10 700	30
5 125	5 685	6 165	6 750	7 395	8 105	8 800	9 435	10 265	11 100	11 100	25
5 675	6 300	6 830	7 475	8 195	8 980	9 750	10 455	11 375	12 300	12 300	20
	9 220	9 995	10 940	11 990	13 140	14 270	15 300	16 650	18 000	18 000	10 CHO
			4 070	4 580	5 090	5 600	6 125	6 500	7 175	<b>7 750</b>	65
		3 740	4 275	4 810	5 345	5 880	6 430	6 825	7 535	8 140	50
3 345	3 900	4 460	5 015	5 575	6 150	6 705	7 100	7 855	8 500	<b>8 500</b>	40
3 510	4 100	4 685	5 270	5 855	6 440	7 045	7 475	8 350	8 915	8 915	30
3 620	4 220	4 825	5 430	6 030	6 635	7 260	7 705	8 505	9 185	9 185	25
	6 415	7 330	8 245	9 160	10 080	11 025	11 700	12 915	13 950	13 950	10 CHO
			4 660	5 240	5 825	6 500	7 035	<b>7 500</b>			65
		4 280	4 895	5 500	6 115	6 825	7 380	7 875			50
3 825	4 460	5 105	5 740	6 380	7 100	7 705	8 250	<b>8 250</b>			40
4 020	4 685	5 360	6 025	6 700	7 475	8 090	8 625	8 625			30
4 140	5 015	5 520	6 210	6 905	7 705	8 335	8 990	8 990			25
	7 340	8 385	9 435	10 485	11 700	12 665	13 500				10 CHO

## Harvester CHO drive wheel (continued)

### Technical data and load capacities

Tyre size	Tread pattern	Service description LI/SS	Rims * (permitted)	Section width (mm)	Overall diameter (mm)	Loaded static radius (mm)	Rolling circumference (mm)	Speed radius index
<b>800/70 R 38 CHO</b>	SFT	181 D (184 A8)	<b>DW 25 B</b> DW 27 B	766 786	2 042	916	6 090	975
<b>900/60 R 38 CHO</b>	SFT	178 D (181 A8)	<b>DW 27 B</b> DW 30 B	860 890	2 060	918	6 115	975
<b>900/60 R 38 CHO</b>	SFT	181 D (184 A8)	<b>DW 27 B</b> DW 30 B	860 890	2 060	918	6 115	975
<b>680/80 R 42 CHO</b>	SFT	180 D (183 A8)	<b>DW 21 B</b> DW 23 B DW 20 B	660 680 650	2 145	983	6 500	1 025
<b>800/70 R 42 CHO</b>	SFT	182 D (185 A8)	<b>DW 25 B</b> DW 27 B	774 794	2 160	945	6 320	1 025
<b>900/60 R 42 CHO</b>	SFT	183 D (186 A8)	<b>DW 27 B</b> DW 28 B DW 30 B	860 870 890	2 140	965	6 400	1 025

\* Further admissible rims on request

Load values for 0.6 bar are for calculating dual and triple load values only.

30 km/h (up to 40 km/h) load values also apply for low-speed high-torque field work.

For plowing with single driven tyres in the furrow, a minimum inflation pressure of 0.8 bar is required.

For intensive road transport at 65/50/40/30 km/h the pressure must be increased by 0.4 bar. Maximum inflation pressure should never be exceeded.

All load values are valid for ground slopes up to and including 20% (11°). When operating on slopes greater than 20%, please, contact the producer.

Load-pressure data for cyclic applications apply to low-torque transport operations at max. speeds of 10 km/h and for a max. distance of 800 meters before discharging the load and returning empty.

By cyclic application (CHO) mean harvester's motion with full grain tank till its discharging.

CHO: Cyclic Harvesting Operation

Tubeless tyres – may be used with a tube.

CHO



	Tyre load capacity (kg) at tyre pressure (bar)										Speed (km/h)
	0.6	0.8	1.0	1.2	1.4	1.6	2.0	2.4	2.8	3.2	
			4 660	5 240	5 825	6 500	7 035	7 500	<b>8 250</b>		65
		4 280	4 895	5 500	6 115	6 825	7 380	7 875	8 665		50
3 825	4 460	5 105	5 740	6 380	7 100	7 705	8 250	<b>9 000</b>		40	
4 020	4 685	5 360	6 025	6 700	7 475	8 090	8 625	9 490		30	
4 140	5 015	5 520	6 210	6 905	7 705	8 335	8 990	9 775		25	
	7 340	8 385	9 435	10 485	11 700	12 665	13 500	14 850		10 CHO	
			4 665	5 170	5 745	6 300	7 020	<b>7 500</b>			65
	4 350	4 900	5 430	6 030	6 615	7 370	7 875			50	
3 895	4 540	5 110	5 660	6 290	6 900	7 685	<b>8 250</b>			40	
4 090	4 765	5 365	5 945	6 605	7 245	8 075	8 625			30	
4 215	4 910	5 530	6 125	6 810	7 465	8 320	8 890			25	
	7 460	8 400	9 310	10 345	11 340	12 635	13 500			10 CHO	
			4 665	5 170	5 745	6 300	7 020	7 500	<b>8 250</b>		65
	4 350	4 900	5 430	6 030	6 615	7 370	7 875	8 665		50	
3 895	4 540	5 110	5 660	6 290	6 900	7 685	7 215	<b>9 000</b>		40	
4 090	4 765	5 365	5 945	6 605	7 245	8 075	8 625	9 490		30	
4 215	4 910	5 530	6 125	6 810	7 465	8 320	8 890	9 775		25	
	7 460	8 400	9 310	10 345	11 340	12 635	13 500	14 850		10 CHO	
			4 255	4 785	5 315	5 800	6 415	6 900	7 490	<b>8 000</b>	65
	3 905	4 470	5 025	5 580	6 090	6 735	7 245	7 865	8 400	<b>8 400</b>	50
3 495	4 075	4 660	5 240	5 820	6 350	7 025	7 555	8 200	<b>8 750</b>	40	
3 670	4 280	4 895	5 505	6 110	6 670	7 375	7 935	8 615	9 200	30	
3 780	4 410	5 040	5 670	6 300	6 875	7 600	8 175	8 875	9 480	25	
	6 700	7 655	8 610	9 570	10 440	11 550	12 420	13 480	14 400	10 CHO	
			4 865	5 470	6 080	6 700	7 340	7 750	<b>8 500</b>		65
	4 470	5 110	5 745	6 385	7 035	7 705	8 140	8 925		50	
3 995	4 660	5 325	5 990	6 660	7 335	8 035	8 485	<b>9 250</b>		40	
4 200	4 895	5 595	6 290	6 990	7 705	8 440	8 915	9 775		30	
4 325	5 040	5 765	6 480	7 205	7 940	8 700	9 185	10 075		25	
	7 660	8 755	9 850	10 945	12 060	13 210	13 950	15 300		10 CHO	
			4 875	5 400	6 005	6 700	7 330	8 000	<b>8 750</b>		65
	4 545	5 120	5 670	6 305	7 035	7 695	8 400	9 190		50	
4 060	4 740	5 340	5 915	6 575	7 335	8 025	8 760	<b>9 500</b>		40	
4 265	4 980	5 605	6 210	6 905	7 705	8 430	9 200	10 065		30	
4 395	5 130	5 775	6 400	7 115	7 940	8 685	9 480	10 370		25	
	7 795	8 775	9 725	10 805	12 060	13 195	14 400	15 750		10 CHO	



## SFT

LOAD CAPACITY	██████████
TRACTION	██████████
SOIL PROTECTION	██████████
HANDLING ON ROAD	███████████
COST EFFICIENCY	███████████



## AC70H

LOAD CAPACITY	██████████
TRACTION	██████████
SOIL PROTECTION	███████████
HANDLING ON ROAD	███████████
COST EFFICIENCY	███████████

# Harvester drive tyres: AC 70 H/G/N and Super Flexion Tyre (SFT)

## Innovative tyres for gentle ground handling with harvesters



**High load capacities** and low inflation pressures.



**Minimized load** placed on soil structure, thanks to the wide and even distribution of ground pressure.



**Low vibration** and smooth on-road ride when moving between fields.



**Very productive and cost-efficient** thanks to performance in the field and in transport.

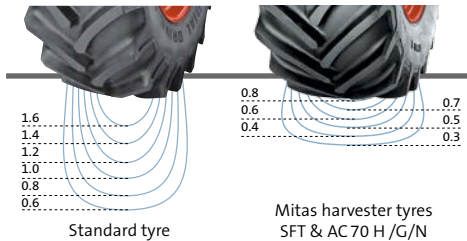

### Soil compaction comparison

The extremely wide tyres distribute the weight of the machine across the surface area, lowering the compaction of the soil.



# Harvester drive wheel

## Technical data and load capacities

Tyre size	Tread pattern	Service description LI/SS	Rims * (permitted)	Section width (mm)	Overall diameter (mm)	Loaded static radius (mm)	Rolling circumference (mm)	Speed radius index
<b>1000/50 R 25</b>	SFT	166 D (172 A8)	<b>36.0 TH</b> 36.0 VA	1 020 1 020	1 655	740	4 930	750
<b>1000/50 R 25</b>	SFT	175 D (178 A8)	<b>36.0 TH</b> 36.0 VA	1 020 1 020	1 655	740	4 930	750
<b>620/75 R 26</b>	SFT	166 A8 (166 B)	<b>DW 20 B</b>	625	1 590	689	4 660	750
<b>650/75 R 32</b>	AC 70 H	167 A8 (164 B)	<b>DW 20 B</b> DW 21 B	650 660	1 795	790	5 255	825
<b>650/75 R 32</b>	AC 75 G	167 A8 (164 B)	<b>DW 20 B</b> DW 21 B	635 645	1 798	782	5 245	825
<b>IF 650/75 R 32</b>	AC 75 G	176 A8	<b>DW 23 B</b> DW 21 B DW 20 B	660 640 630	1 770	782	5 245	825



SFT



AC70H



Tyre load capacity (kg) at tyre pressure (bar)												Speed (km/h)
0.6	0.8	1.0	1.2	1.4	1.6	2.0	2.4	2.8	3.2	4.0		
		3 315	3 675	4 080	4 490	4 985	<b>5 300</b>					65
	3 185	3 585	3 975	4 400	4 825	5 355	5 735					50
3 000	3 500	3 940	4 365	4 850	5 335	5 925	<b>6 300</b>					40
3 210	3 745	4 215	4 675	5 190	5 710	6 340	6 740					30
3 330	3 885	4 375	4 845	5 385	5 925	6 575	6 995					25
3 690	4 305	4 845	5 370	5 970	6 565	7 290	7 750					20
3 900	4 550	5 125	5 675	6 310	6 940	7 705	8 190					10
4 800	5 600	6 305	6 985	7 765	8 540	9 480	10 080					10 Cyclic
		3 940	4 365	4 835	5 300	5 885	6 300	<b>6 900</b>				65
	3 675	4 135	4 585	5 075	5 565	6 180	6 615	7 245				50
3 335	3 830	4 315	4 780	5 295	5 800	6 445	6 900	<b>7 500</b>				40
3 500	4 025	4 530	5 020	5 560	6 095	6 765	7 245	7 935				30
3 605	4 145	4 670	5 175	5 730	6 280	6 970	7 465	8 175				25
3 745	4 305	4 845	5 370	5 945	6 520	7 235	7 750	8 485				20
3 955	4 550	5 125	5 675	6 285	6 890	7 650	8 190	8 970				10
4 870	5 600	6 305	6 985	7 735	8 480	9 415	10 080	11 040				10 Cyclic
		2 835	3 190	3 545	3 875	4 280	4 500	4 995	<b>5 300</b>			50
	2 480	2 835	3 190	3 545	3 875	4 280	4 500	4 995	<b>5 300</b>			40
	2 655	3 035	3 415	3 795	4 145	4 580	4 815	5 345	5 670			30
	2 755	3 150	3 540	3 935	4 300	4 750	4 995	5 540	5 885			25
	3 050	3 490	3 925	4 360	4 765	5 265	5 535	6 140	6 520			20
	3 225	4 535	4 150	5 670	5 040	5 565	5 850	6 490	6 890	7 570		10
	3 970	5 580	5 105	6 975	6 200	6 845	7 200	7 990	8 480	9 320		10 Cyclic
		3 200	3 500	3 835	4 160	4 565	<b>5 000</b>					50
	3 245	3 515	3 850	4 215	4 500	5 020	<b>5 450</b>					40
3 125	3 470	3 760	4 120	4 510	4 895	5 370	5 835					30
3 245	3 600	3 900	4 270	4 680	5 075	5 570	6 050					25
3 595	3 990	4 325	4 735	5 185	5 625	6 170	6 705		(3.1 bar)			20
3 800	4 215	4 570	5 005	5 480	5 945	6 525	7 085	7 610	8 000			10
4 675	5 190	5 625	6 155	6 745	7 315	8 030	8 725	9 370	9 845			10 Cyclic
		3 200	3 500	3 835	4 160	4 565	<b>5 000</b>					50
	3 245	3 515	3 850	4 215	4 500	5 020	<b>5 450</b>					40
3 125	3 470	3 760	4 120	4 510	4 895	5 370	5 835					30
3 245	3 600	3 900	4 270	4 680	5 075	5 570	6 050					25
3 595	3 990	4 325	4 735	5 185	5 625	6 170	6 705		(3.1 bar)			20
3 800	4 215	4 570	5 005	5 480	5 945	6 525	7 085	7 610	8 000			10
4 675	5 190	5 625	6 155	6 745	7 315	8 030	8 725	9 370	9 845			10 Cyclic
		4 000	4 500	5 000	5 450	6 000	6 500	<b>7 100</b>				40
2 705	3 080	3 520	3 960	4 400	4 795	5 280	5 720	6 250				40 Dual
		6 160	6 975	7 700	8 450	9 300	10 075	11 005				15 CFO
4 295	4 775	5 440	6 140	6 800	7 435	8 185	8 865	9 685				15 CFO Dual

## Harvester drive wheel (continued)

### Technical data and load capacities

Tyre size	Tread pattern	Service description LI/SS	Rims * (permitted)	Section width (mm)	Overall diameter (mm)	Loaded static radius (mm)	Rolling circumference (mm)	Speed radius index	
<b>650/75 R 32</b>	AC 70 G	172 A8 (169 B)	<b>DW 20 B</b> DW 21 B	650 660	1 795	790	5 255	825	
<b>680/85 R 32</b>	AC 70 G	173 A8 (170 B)	<b>DW 20 B</b> DW 21 B DW 23 B	662 672 692	1 960	852	5 865	925	
<b>680/85 R 32</b>	AC 70 G	178 A8 (175 B)	<b>DW 20 B</b> DW 21 B DW 23 B	662 672 692	1 960	852	5 865	925	
<b>800/65 R 32</b>	AC 70 H	167 A8 (164 B)	<b>DW 25 B</b> DW 27 B	795 815	1 820	830	5 430	875	
<b>800/65 R 32</b>	AC 70 H	172 A8 (169 B)	<b>DW 25 B</b> DW 27 B	795 815	1 820	830	5 430	875	
<b>800/65 R 32</b>	AC 70 N	178 A8 (175 B)	<b>DW 25 B</b> DW 27 B	743 763	1 835	837	5 500	875	

SFT



AC70H



Tyre load capacity (kg) at tyre pressure (bar)												Speed (km/h)
0.6	0.8	1.0	1.2	1.4	1.6	2.0	2.4	2.8	3.2	4.0		
		3 200	3 500	3 835	4 160	4 565	5 000	5 330	<b>5 800</b>			50
	3 245	3 515	3 850	4 215	4 500	5 020	5 450	5 855	<b>6 300</b>			40
3 125	3 470	3 760	4 120	4 510	4 895	5 370	5 835	6 265	6 740			30
3 245	3 600	3 900	4 270	4 680	5 075	5 570	6 050	6 500	6 995			25
3 595	3 990	4 325	4 735	5 185	5 625	6 170	6 705	7 200	7 750			20
3 800	4 215	4 570	5 005	5 480	5 945	6 525	7 085	7 610	8 190	9 235		10
4 675	5 190	5 625	6 155	6 745	7 315	8 030	8 725	9 370	10 080	11 365		10 Cyclic
		3 865	4 230	4 635	5 025	5 515	<b>6 000</b>					50
	3 915	4 245	4 645	5 090	5 520	6 060	<b>6 500</b>					40
3 775	4 190	4 540	4 975	5 445	5 910	6 485	6 955					30
3 915	4 345	4 710	5 155	5 650	6 130	6 725	7 215					25
4 340	4 815	5 220	5 715	6 260	6 790	7 450	7 995		(3.1 bar)			20
4 585	5 090	5 520	6 040	6 620	7 175	7 875	8 450	9 190	9 655			10
5 645	6 265	6 790	7 435	8 145	8 835	9 695	10 400	11 310	11 885			10 Cyclic
		3 865	4 230	4 635	5 025	5 515	6 000	6 435	<b>6 900</b>			50
	3 915	4 245	4 645	5 090	5 520	6 060	6 500	7 070	<b>7 500</b>			40
3 775	4 190	4 540	4 975	5 445	5 910	6 485	6 955	7 565	8 025			30
3 915	4 345	4 710	5 155	5 650	6 130	6 725	7 215	7 850	8 325			25
4 340	4 815	5 220	5 715	6 260	6 790	7 450	7 995	8 695	9 225			20
4 585	5 090	5 520	6 040	6 620	7 175	7 875	8 450	9 190	9 750	11 150		10
5 645	6 265	6 790	7 435	8 145	8 835	9 695	10 400	11 310	11 995	13 720		10 Cyclic
		3 900	4 270	4 610	<b>5 000</b>							50
	3 950	4 285	4 690	5 065	<b>5 450</b>							40
3 810	4 230	4 585	5 020	5 420	5 830							30
3 955	4 385	4 755	5 205	5 625	6 050							25
4 380	4 860	5 270	5 770	6 230	6 705							20
4 630	5 140	5 570	6 100	6 585	7 085	7 630						10
5 700	6 325	6 855	7 505	8 105	8 720	9 390						10 Cyclic
		3 900	4 270	4 610	5 000	5 310	<b>5 800</b>					50
	3 950	4 285	4 690	5 065	5 450	5 835	<b>6 300</b>					40
3 810	4 230	4 585	5 020	5 420	5 830	6 245	6 745					30
3 955	4 385	4 755	5 205	5 625	6 050	6 475	6 995					25
4 380	4 860	5 270	5 770	6 230	6 705	7 175	7 750					20
4 630	5 140	5 570	6 100	6 585	7 085	7 585	8 190	8 960	9 400	(3.1 bar)		10
5 700	6 325	6 855	7 505	8 105	8 720	9 335	10 085	11 025	11 570			10 Cyclic
		3 900	4 270	4 610	5 000	5 310	5 800	6 270	<b>6 900</b>			50
	3 950	4 285	4 690	5 065	5 450	5 835	6 300	6 890	<b>7 500</b>			40
3 810	4 230	4 585	5 020	5 420	5 830	6 245	6 745	7 375	8 025			30
3 955	4 385	4 755	5 205	5 625	6 050	6 475	6 995	7 650	8 325			25
4 380	4 860	5 270	5 770	6 230	6 705	7 175	7 750	8 475	9 225			20
4 630	5 140	5 570	6 100	6 585	7 085	7 585	8 190	8 960	9 750	10 820		10
5 700	6 325	6 855	7 505	8 105	8 720	9 335	10 085	11 025	12 000	13 320		10 Cyclic

## Harvester drive wheel (continued)

### Technical data and load capacities

Tyre size	Tread pattern	Service description LI/SS	Rims * (permitted)	Section width (mm)	Overall diameter (mm)	Loaded static radius (mm)	Rolling circumference (mm)	Speed radius index
<b>800/70 R 32</b>	SFT	175 A8 (172 B)	<b>DW 25 B</b> DW 27 B	762 784	1 932	845	5 630	925
<b>900/60 R 32</b>	SFT	176 A8 (173 B)	<b>DW 27 B</b> DW 30 B	857 890	1 905	850	5 700	925
<b>900/60 R 32</b>	SFT	181 A8 (178 B)	<b>DW 27 B</b> DW 30 B	857 890	1 905	850	5 700	925
<b>900/70 R 32</b>	SFT	188 A8 (185 B)	<b>DW 27 B</b> DW 30 B	895 925	2 050	896	6 050	975
<b>1050/50 R 32</b>	SFT	178 A8 (178 B)	<b>36.00 VA</b>	1 015	1 890	845	5 640	875
<b>1250/50 R 32</b>	SFT	188 A8 (185 B)	<b>40"</b> 44"	1 180 1 220	2 020	890	6 000	975

SFT



AC70H



Tyre load capacity (kg) at tyre pressure (bar)												Speed (km/h)
0.6	0.8	1.0	1.2	1.4	1.6	2.0	2.4	2.8	3.2	4.0		
		4 180	4 575	5 010	5 460	5 965	<b>6 300</b>					50
	4 235	4 590	5 025	5 505	6 000	6 555	<b>6 900</b>					40
4 085	4 530	4 915	5 380	5 895	6 420	7 015	7 385					30
4 235	4 700	5 095	5 580	6 115	6 600	7 275	7 660					25
4 695	5 210	5 650	6 180	6 775	7 380	8 060	8 485					20
4 960	5 505	5 970	6 535	7 160	7 800	8 520	8 970	10 350				10
6 105	6 775	7 345	8 040	8 810	9 600	10 485	11 040	11 730				10 Cyclic
		4 250	4 650	5 020	5 460	5 950	<b>6 500</b>					50
	4 315	4 670	5 110	5 515	6 000	6 535	<b>7 100</b>					40
4 165	4 615	5 000	5 465	5 900	6 420	6 995	7 595					30
4 320	4 790	5 185	5 670	6 120	6 660	7 255	7 880					25
4 790	5 305	5 745	6 285	6 785	7 380	8 040	8 735					20
5 060	5 610	6 070	6 640	7 170	7 800	8 495	9 230	10 650				10
6 230	6 905	7 475	8 175	8 825	9 600	10 460	11 360	12 070				10 Cyclic
		4 250	4 650	5 020	5 460	5 950	6 500	7 025				50
	4 315	4 670	5 110	5 515	6 000	6 535	7 100	7 720	<b>7 500</b>			40
4 165	4 615	5 000	5 465	5 900	6 420	6 995	7 595	8 260	<b>8 250</b>			30
4 320	4 790	5 185	5 670	6 120	6 660	7 255	7 880	8 570	9 160			25
4 790	5 305	5 745	6 285	6 785	7 380	8 040	8 735	9 495	10 150			20
5 060	5 610	6 070	6 640	7 170	7 800	8 495	9 230	10 810	11 550	13 055		10
6 230	6 905	7 475	8 175	8 825	9 600	10 460	11 360	12 350	13 200	14 920		10 Cyclic
		4 660	5 055	5 530	6 060	6 700	7 215	7 750	8 415			50
	4 615	5 120	5 555	6 080	6 660	7 300	7 925	8 500	9 250	<b>9 250</b>		40
	4 940	5 480	5 945	6 505	7 125	7 810	8 480	9 095	9 895	<b>10 000</b>		30
	5 125	5 685	6 165	6 750	7 395	8 105	8 800	9 435	10 265	11 100		25
	5 675	6 300	6 830	7 475	8 195	8 980	9 750	10 455	11 375	12 300		20
	6 000	6 660	7 220	7 905	8 660	9 490	10 305	11 050	12 025	13 000	14 585	10
	7 385	8 195	8 885	9 725	10 655	11 680	12 685	13 600	14 800	16 000	17 950	10 Cyclic
		5 045	5 515	5 955	6 500	7 055	<b>7 500</b>					50
	4 495	4 985	5 395	5 900	6 370	6 955	7 550	8 025				40
	4 665	5 170	5 595	6 120	6 610	7 215	7 830	8 325				30
	5 170	5 730	6 200	6 785	7 320	7 995	8 680	9 225				25
	5 465	6 055	6 555	7 170	7 740	8 450	9 175	9 750	11 250			20
	6 725	7 450	8 070	8 825	9 525	10 400	11 290	12 000	12 750			10
		5 020	5 655	6 265	6 960	7 750	8 500	<b>9 250</b>				50
	4 730	5 515	6 210	6 885	7 650	8 500	9 340	<b>10 000</b>				40
	5 060	5 905	6 645	7 265	8 185	9 095	9 995	10 700				30
	5 250	6 125	6 895	7 640	8 490	9 435	10 370	11 100				25
	5 815	6 785	7 640	8 470	9 410	10 455	11 490	12 300				20
	6 620	7 725	8 695	9 640	10 710	11 900	13 075	14 000				10
	7 565	8 825	9 940	11 015	12 240	13 600	14 945	16 000	17 655			10 Cyclic

## Harvester drive wheel (continued)

### Technical data and load capacities

Tyre size	Tread pattern	Service description LI/SS	Rims * (permitted)	Section width (mm)	Overall diameter (mm)	Loaded static radius (mm)	Rolling circumference (mm)	Speed radius index
<b>1250/50 R 32</b>	SFT	194 A8 (191 B)	<b>40"</b> 44"	1 180 1 220	2 020	890	6 000	975
<b>900/60 R 38</b>	SFT	178 D (181 A8)	<b>DW 27 B</b> DW 30 B	870 900	2 060	918	6 115	975
<b>580/85 R 42</b>	SFT	163 D (166 A8)	<b>W 18 L</b> DW 20 B DW 21 B	567 587 597	2 045	920	6 100	975
<b>680/80 R 42</b>	SFT	180 D (183 A8)	<b>DW 21 B</b> DW 23 B DW 20 B	660 680 650	2 160	965	6 400	1 025

\* Further admissible rims on request

Load values for 0.6 bar are for calculating dual and triple load values only.

30 km/h (up to 40 km/h) load values also apply for low-speed high-torque field work.

For plowing with single driven tyres in the furrow, a minimum inflation pressure of 0.8 bar is required.

For intensive road transport at 65/50/40/30 km/h the pressure must be increased by 0.4 bar. Maximum inflation pressure should never be exceeded.

All load values are valid for ground slopes up to and including 20% (11°). When operating on slopes greater than 20%, please, contact the producer. Load-pressure data for cyclic applications apply to low-torque transport operations at max. speeds of 10 km/h and for a max. distance of 800 meters before discharging the load and returning empty.

By cyclic application is means harvester's motion with full grain tank till its discharging.

Tubeless tyres – may be used with a tube.

SFT



AC70H



	Tyre load capacity (kg) at tyre pressure (bar)											Speed (km/h)
	0.6	0.8	1.0	1.2	1.4	1.6	2.0	2.4	2.8	3.2	4.0	
		5 020	5 655	6 265	6 960	7 750	8 500	9 250	10 040	<b>10 900</b>		50
4 730	5 515	6 210	6 885	7 650	8 500	9 340	10 000	11 035	<b>11 800</b>		40	
5 060	5 905	6 645	7 265	8 185	9 095	9 995	10 700	11 805	12 625		30	
5 250	6 125	6 895	7 640	8 490	9 435	10 370	11 100	12 245	13 100		25	
5 815	6 785	7 640	8 470	9 410	10 455	11 490	12 300	13 570	14 515		20	
6 620	7 725	8 695	9 640	10 710	11 900	13 075	14 000	15 445	16 520		10	
7 565	8 825	9 940	11 015	12 240	13 600	14 945	16 000	17 655	18 880		10 Cyclic	
		4 875	5 325	5 825	6 300	6 985	<b>7 500</b>				65	
	4 610	5 120	5 595	6 115	6 615	7 335	7 875				50	
4 235	4 805	5 340	5 835	6 375	6 900	7 650	<b>8 250</b>				40	
4 450	5 050	5 605	6 125	6 695	7 245	8 035	8 625				30	
4 585	5 200	5 780	6 315	6 900	7 465	8 280	8 890				25	
4 755	5 400	5 995	6 555	7 165	7 750	8 590	9 225				20	
5 415	6 145	6 825	7 460	8 155	8 820	9 780	10 500		11 250		10	
6 190	7 025	7 800	8 525	9 315	10 080	11 175	12 000		12 750		10 Cyclic	
		3 605	3 945	4 405	<b>4 875</b>						65	
	3 405	3 785	4 140	4 630	5 120						50	
3 125	3 550	3 950	4 320	4 825	<b>5 300</b>						40	
3 285	3 730	4 145	4 535	5 070	5 605						30	
3 375	3 834	4 266	4 666	5 211	5 724						25	
3 500	3 976	4 424	4 838	5 404	5 936						20	
3 995	4 540	5 050	5 520	6 170	6 825	7 260					10	
4 570	5 190	5 770	6 310	7 050	7 800	8 290					10 Cyclic	
		4 495	4 920	5 390	5 800	6 415	6 900	7 490	<b>8 000</b>		65	
3 920	4 350	4 720	5 165	5 660	6 090	6 735	7 245	7 865	8 400		50	
4 090	4 540	4 920	5 385	5 900	6 300	7 025	7 500	8 200	<b>8 750</b>		40	
4 295	4 765	5 170	5 660	6 200	6 670	7 375	7 935	8 615	9 200		30	
4 425	4 910	5 325	5 830	6 385	6 875	7 600	8 175	8 875	9 480		25	
4 595	5 100	5 530	6 055	6 630	7 135	7 895	8 485	9 210	9 840		20	
4 855	5 390	5 845	6 400	7 010	7 540	8 345	8 970	9 735	10 400	11 810	10	
5 980	6 635	7 195	7 875	8 625	9 280	10 270	11 040	11 980	12 800	14 535	10 Cyclic	



## SFT IMP

LOAD CAPACITY	██████████
TRACTION	██████████
SOIL PROTECTION	██████████
HANDLING ON ROAD	██████████
COST EFFICIENCY	██████████



## AC 65 IMP

LOAD CAPACITY	██████████
TRACTION	██████████
SOIL PROTECTION	██████████
HANDLING ON ROAD	██████████
COST EFFICIENCY	██████████



## AC 70 G IMP

LOAD CAPACITY	██████████
TRACTION	██████████
SOIL PROTECTION	██████████
HANDLING ON ROAD	██████████
COST EFFICIENCY	██████████



# Super Flexion Tyre (SFT IMP), AC 65 IMP & AC 70 G IMP

Tremendous flexion and load capacity make these tyres a great fit for the steering axle of a harvester



**Outstanding traction** thanks to very large ground contact patch.



**High load capacity** and optimal ground pressure distribution reduces soil compaction.



**Long tyre life** through optimized tread pattern design and high resistance to damage.



**Suitable also for free-rolling** field applications.



# Harvester Steering wheel

## Technical data and load capacities

Tyre size	Tread pattern	Tube Valve	Rims * (permitted)	Section width (mm)	Overall diameter (mm)	Loaded static radius (mm)	Rolling circumference (mm)
<b>460/70 R 24 IMP</b>	AC 70 G	–	<b>W 15 L</b> W 16 L W 14 L	455 465 445	1 236	552 ☺ 528 ☺☹	3 690 ☺ 3 620 ☺☹
<b>500/70 R 24 IMP</b>	AC 70 G	–	<b>W 16 L</b> W 15 L	496 486	1 313	591 ☺ 573 ☺☹	3 919 ☺ 3 908 ☺☹
<b>500/85 R 24 IMP</b>	SFT	S 18.4(15)-26 T 47GW S	<b>W 16 L</b> W 15 L	528 518	1 458	650 ☺ 621 ☺☹	4 325 ☺ 4 237 ☺☹
<b>500/85 R 24 IMP</b>	SFT	S 18.4(15)-26 T 47GW S	<b>W 16 L</b> W 15 L	546 536	1 458	645 ☺ 615 ☺☹	4 315 ☺ 4 225 ☺☹
<b>500/85 R 24 IMP</b>	SFT	S 18.4(15)-26 T 47GW S	<b>W 16 L</b> W 15 L	527 517	1 461	645 ☺ 615 ☺☹	4 315 ☺ 4 225 ☺☹
<b>500/80 R 28 IMP</b>	SFT	S 18.4(15)-26 T 47GW S	<b>W 16 L</b> W 15 L	517 507	1 495	663 ☺ 635 ☺☹	4 440 ☺ 4 355 ☺☹
<b>500/80 R 28 IMP</b>	SFT	S 18.4(15)-26 T 47GW S	<b>W 16 L</b> W 15 L	517 507	1 495	663 ☺ 635 ☺☹	4 440 ☺ 4 355 ☺☹
<b>600/65 R 28 IMP</b>	AC 65	S 18.4(15)-26 T 47GW S	<b>W 18 L</b> DW 18 L W 16 L	590 590 570	1 485	661 ☺ 640 ☺☹	4 411 ☺ 4 340 ☺☹
<b>500/85 R 30 IMP</b>	SFT	S 18.4(15)-26 T 47GW S	<b>W 16L</b> W 15L	527 517	1 605	711 ☺ 680 ☺☹	4 750 ☺ 4 669 ☺☹
<b>500/85 R 30 IMP</b>	SFT N	S 18.4(15)-26 T 47GW S	<b>W 16L</b> W 15L	506 496	1 606	711 ☺ 680 ☺☹	4 750 ☺ 4 669 ☺☹
<b>540/65 R 30 IMP</b>	AC 65	–	<b>W 16 L</b> W 18 L W 15 L	526 546 516	1 485	664 ☺ 648 ☺☹	4 420 ☺ 4 365 ☺☹
<b>620/70 R 30 IMP</b>	SFT	–	<b>W 18 L</b> DW 20 B DW 21 B	625 645 655	1 595	700 ☺ 680 ☺☹	4 870 ☺ 4 770 ☺☹
<b>620/70 R 30 IMP</b>	SFT N	–	<b>W 18 L</b> DW 20 B DW 21 B	600 620 630	1 595	700 ☺ 680 ☺☹	4 870 ☺ 4 770 ☺☹
<b>620/75 R 30 IMP</b>	SFT	–	<b>W 18 L</b> DW 20 B DW 21 B	590 610 620	1 692	753 ☺ 730 ☺☹	5 000 ☺ 4 950 ☺☹
<b>710/60 R 30 IMP</b>	SFT	–	<b>DW 21 B</b> DW 23 B	690 710	1 625	724 ☺ 680 ☺☹	4 830 ☺ 4 690 ☺☹
<b>710/65 R 30 IMP</b>	SFT	–	<b>DW 23 B</b> DW 25 B	708 728	1 698	755 ☺ 730 ☺☹	5 000 ☺ 4 950 ☺☹

AC 65



SFT



	Service description LI/SS	Tyre load capacity (kg) at tyre pressure (bar)								Speed (km/h)	
		0.8	1.2	1.6	2.0	2.4	2.8	3.2	3.6		4.0
	151 A8 ↻ 163 A8 ↻	1 350 1 905	1 735 2 450	2 120 2 995	2 455 3 465	2 790 3 940	3 110 4 395	<b>3 450</b> <b>4 875</b>			40 40
	155 A8 ↻ 164 A8 ↻	1 685 2 170	2 165 2 790	2 645 3 410	3 065 3 950	3 480 4 490	<b>3 875</b> <b>5 000</b>				40 40
	158 A8 ↻ 171 A8 ↻	1 795 2 600	2 310 3 340	2 820 4 085	3 270 4 730	3 715 5 375	<b>4 250</b> <b>6 150</b>				40 40
	165 A8 ↻ 177 A8 ↻		2 310 3 340	2 820 4 085	3 270 4 730	3 715 5 375	4 250 6 150	4 675 6 630	<b>5 150</b> <b>7 300</b>		40 40
	161 A8 ↻ 182 A8 ↻		2 430 3 550	3 000 4 250	3 350 5 000	3 550 5 800	3 875 6 500	4 125 6 900	4 375 7 750	<b>4 625</b> <b>8 500</b>	40 40
	164 A8 ↻ 176 A8 ↻	1 940 2 755	2 495 3 540	3 050 4 330	3 530 5 015	4 015 5 700	4 480 6 360	<b>5 000</b> <b>7 100</b>			40 40
	162 A8 ↻ 182 A8 ↻		2 500 3 550	3 000 4 375	3 350 5 000	3 550 5 800	3 875 6 500	4 125 7 100	4 500 7 750	<b>4 750</b> <b>8 500</b>	40 40
	156 A8 ↻ 168 A8 ↻	2 170 3 040	2 790 3 910	3 410 4 775	<b>4 000</b> <b>5 600</b>						40 40
	164 A8 ↻ 176 A8 ↻	2 110 2 995	2 715 3 855	3 315 4 710	3 840 5 455	4 365 6 200	<b>5 000</b> <b>7 100</b>				40 40
	164 A8 ↻ 176 A8 ↻	2 110 2 995	2 715 3 855	3 315 4 710	3 840 5 455	4 365 6 200	<b>5 000</b> <b>7 100</b>				40 40
	156 A8 ↻ 168 A8 ↻	1 900 2 660	2 445 3 420	2 985 4 180	3 460 4 840	<b>4 000</b> <b>5 600</b>					40 40
	166 A8 ↻ 178 A8 ↻	2 490 3 525	3 205 4 535	3 915 5 540	4 535 6 415	<b>5 300</b> <b>7 500</b>					40 40
	166 A8 ↻ 178 A8 ↻	2 490 3 525	3 205 4 535	3 915 5 540	4 535 6 415	<b>5 300</b> <b>7 500</b>					40 40
	168 A8 ↻ 180 A8 ↻	2 620 3 750	3 410 4 875	4 200 6 000	4 825 6 900	<b>5 600</b> <b>8 000</b>					40 40
	162 A8 ↻ 180 A8 ↻	2 580 3 795	3 220 4 880	3 875 5 965	4 385 6 905	<b>4 750</b> <b>8 000</b>					40 40
	165 A8 ↻ 182 A8 ↻	2 855 4 080	3 570 5 250	4 250 6 415	4 735 7 430	<b>5 150</b> <b>8 500</b>					40 40

## Harvester Steering wheel (continued)

### Technical data and load capacities

Tyre size	Tread pattern	Tube Valve	Rims * (permitted)	Section width (mm)	Overall diameter (mm)	Loaded static radius (mm)	Rolling circumference (mm)	
500/85 R 34 IMP	SFT	–	W 16 L	503	1 705	755 ⊕	5 050 ⊕	
			W 15 L	493		745 ⊕→	5 000 ⊕→	
500/85 R 34 IMP	SFT N	–	W 16 L	506	1 706	755 ⊕	5 050 ⊕	
			W 15 L	496		745 ⊕→	5 000 ⊕→	

\* Further admissible rims on request

\* In preparation, please contact Mitas for availability

⊕ – drive wheel

⊕→ – free rolling wheel

When fitted on tractor steering axle, 80% of load “free rolling” applies

For intensive road transport at 40/30 km/h the pressure must be increased by 0.4 bar. Maximum inflation pressure should never be exceeded.

All load values are valid for ground slopes up to and including 20% (11°). When operating on slopes greater than 20%, please, contact the producer.

Tubeless tyres – may be used with a tube.

AC 65



SFT



Service description L/SS	Tyre load capacity (kg) at tyre pressure (bar)									Speed (km/h)
	0.8	1.2	1.6	2.0	2.4	2.8	3.2	3.6	4.0	
166 A8 ⊕	2 555	3 195	3 515	4 070	4 630	<b>5 300</b>				40
178 A8 ⊕→	3 620	4 525	4 975	5 760	6 550	<b>7 500</b>				40
166 A8 ⊕	2 555	3 195	3 515	4 070	4 630	<b>5 300</b>				40
178 A8 ⊕→	3 620	4 525	4 975	5 760	6 550	<b>7 500</b>				40

# Conversion table

Size designation in Inches	Size designation in millimetres				Speed radius index
	95–85 series	80 series	75 series	70 series	
				200/70 R 16 AC 70 T	330
				240/70 R 16 AC 70 T	350
				260/70 R 16 AC 70 T	360
				280/70 R 16 AC 70 T	390
				280/70 R 18 AC 70 T	410
				280/70 R 20 AC 70 T	425
				300/70 R 20 AC 70 T	450
11.2 R 20	280/85 R 20 AC 85			320/70 R 20 AC 70 T	475
				360/70 R 20 AC 70 T	500
11.2 R 24	280/85 R 24 AC 85			380/70 R 20 AC 70 T	525
				320/70 R 24 HC 70 / AC 70 T	525
12.4 R 24	320/85 R 24 AC 85			360/70 R 24 HC 70 / AC 70 T	550
13.6 R 24	340/85 R 24 AC 85			380/70 R 24 HC 70 / AC 70 T	575
11.2 R 28	280/85 R 28 AC 85			/ AC 70 G	
14.9 R 24	380/85 R 24 AC 85			420/70 R 24 HC 70 / AC 70 T	600
12.4 R 28	320/85 R 28 AC 85			/ AC 70 G	
16.9 R 24	420/85 R 24 AC 85	440/80 R 24 HCM		480/70 R 24 HC 70 / AC 70 T	625
				/ AC 70 G	
13.6 R 28	340/85 R 28 AC 85			380/70 R 28 HC 70 / AC 70 T	625
14.9 R 28	380/85 R 28 AC 85	400/80 R 28 HCM		420/70 R 28 HC 70 / AC 70 T	650
				/ AC 70 G	
16.9 R 28	420/85 R 28 AC 85	440/80 R 28 HCM		480/70 R 28 HC 70 / AC 70 T	675
14.9 R 30	380/85 R 30 AC 85			420/70 R 30 HC 70 / AC 70 T	
16.9 R 30	420/85 R 30 AC 85			480/70 R 30 HC 70	700
				480/70 R 30 AC 70 T / AC 70 G	
18.4 R 30	460/85 R 30 AC 85			600/70 R 28 SFT	725
14.9 R 34	380/85 R 34 AC 85				
16.9 R 34	VF 420/85 R 34 HC 2000	380/80 R 38 AC 85	620/75 R 26 SFT	VF 600/70 R 30 HC 2000	750
	420/85 R 34 AC 85			600/70 R 30 SFT	
13.6 R 38	340/85 R 38 AC 85			480/70 R 34 HC 70	
				/ AC 70 T / AC 70 G	
18.4 R 34	460/85 R 34 AC 85			520/70 R 34 HC 70	775
				/ AC 70 T / AC 70 G	
16.9 R 38	VF 380/95 R 38 HC 2000			480/70 R 38 HC 70 / AC 70 T	800
	420/85 R 38 AC 85				
18.4 R 38	460/85 R 38 AC 85	480/80 R 38 HCM	IF 650/75 R 32 AC 75 G	520/70 R 38 HC 70 / AC 70 T	825
			650/75 R 32 AC 70 H	/ AC 70 G	
			650/75 R 32 AC 75 G		

	Size designation in millimetres				Size designation in Inches	Speed radius index
	65 series	60 series	55–50 series	Row Crop		
						330
						350
						360
	320/65 R 16 AC 65					390
						410
						425
						450
						475
	420/65 R 20 AC 65					500
						525
						550
	440/65 R 24 AC 65					575
	480/65 R 24 AC 65			270/80 R 32 AC 90	9.5 R 32	600
	540/65 R 24 AC 65			270/95 R 32 AC 85		625
	440/65 R 28 AC 65					
	480/65 R 28 AC 65			320/85 R 32 AC 85 270/80 R 36 AC 90	12.4 R 32 9.5 R 36	650
	540/65 R 28 SFT 540/65 R 28 AC 65			320/90 R 32 AC 85 320/85 R 34 AC 85	12.4 R 34	675
	600/65 R 28 SFT 600/65 R 28 AC 65 540/65 R 30 SFT 540/65 R 30 AC 65					700
	600/65 R 30 AC 65		710/55 R 30 SFT	320/85 R 38 AC 85 13.6 R 36 AC 90	12.4 R 38	725
	750/65 R 26 SFT 540/65 R 34 AC 65	710/60 R 30 SFT	750/55 R 30 SFT	340/85 R 38 AC 85 300/85 R 42 AC 90 15.5 R 38 AC 51	13.6 R 38 11.2 R 42	750
	600/65 R 34 AC 65	650/60 R 34 SFT		300/95 R 42 AC 90	12.4 R 42	775
	540/65 R 38 AC 65		1050/50 R 25 SFT	IF 320/90 R 42 AC 85 320/90 R 42 AC 85 380/95 R 38 AC 85		800
	650/65 R 34 SFT 600/65 R 38 SST / AC 65	710/60 R 34 SFT		320/95 R 46 AC 85 270/95 R 48 AC 90	11.2 R 48	825

## Conversion table (continued)

Size designation in Inches	Size designation in millimetres				Speed radius index	
	95–85 series	80 series	75 series	70 series		
20.8 R 38	520/85 R 38 AC 85	VF 580/80 R 34 HC 3000 480/80 R 42 AC 85		580/70 R 38 HC 70 580/70 R 38 AC 70 T	875	
20.8 R 42	520/85 R 42 AC 85 680/85 R 32 CHO AC 70 G 680/85 R 32 AC 70 G	480/80 R 46 AC 85	650/75 R 38 SFT	710/70 R 38 SFT 710/70 R 38 AC 65 800/70 R 32 CHO SFT 800/70 R 32 SFT	925	
20.8 R 46	650/85 R 38 SFT 580/85 R 42 SFT 520/85 R 46 AC 85	VF 480/80 R 50 HC 1000 480/80 R 50 AC 85	650/75 R 42 SFT	800/70 R 38 SFT VF 710/70 R 42 HC 2000 710/70 R 42 SFT 900/70 R 32 CHO SFT 900/70 R 32 SFT 800/70 R 38 CHO SFT	975	
		680/80 R 42 CHO SFT 680/80 R 42 SFT	710/75 R 42 SFT		1 025	
	VF 480/95 R 50 HC 2000 480/95 R 50 AC 85				1 075	



	Size designation in millimetres				Size designation in Inches	Speed radius index
	65 series	60 series	55–50 series	Row Crop		
	650/65 R 38 SFT 650/65 R 38 SST / AC 65 800/65 R 32 AC 70 H 800/65 R 32 AC 70 N		1050/50 R 32 SFT	VF 380/90 R 46 HC 1000 380/90 R 46 AC 85 340/90 R 48 AC 85 320/90 R 50 AC 85	14.9 R 46 13.6 R 48	875
	650/65 R 42 SST / AC 65	900/60 R 32 CHO SFT 900/60 R 32 SFT		380/90 R 50 AC 85 320/90 R 54 AC 85	14.9 R 50	925
		900/60 R 38 CHO SFT 900/60 R 38 SFT	1250/50 R 32 SFT	VF 320/105 R 54 HC 1000 VF 380/105 R 50 HC 1000		975
	IF 710/65 R 46 SFT 710/65 R 46 SFT	900/60 R 42 SFT		380/105 R 54 AC 85		1 025
						1 075



## Agriterra 02



## Agriterra 03



# Agriterra 02 and 03

## New generation of fast and powerful agricultural tyres



Agriterra 02 – **Gentle to grassland** due to high positive share and round shoulder.



Agriterra 03 – **Excellent self-cleaning properties** due to higher negative share and distinctive shoulder.



**Low noise emission** thanks optimized tread pattern.



**Wide agricultural use:** flat trucks, fast-moving agricultural trailers, tank containers etc.

The bigger tread pattern contact area

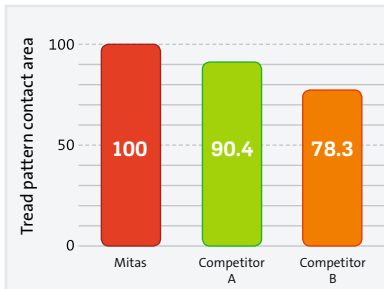

High operating economy on the road and in the field

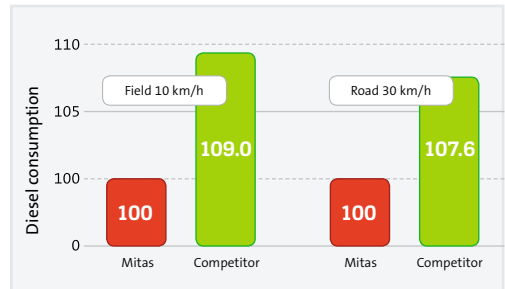

Tested tyre size 600/55 R 26.5 IMP



# Agriterra

## Technical data and load capacities

Tyre size	Tread pattern	Service description LI/SS	Rims * (permitted)	Section width (mm)	Overall diameter (mm)	Loaded static radius (mm)	Rolling circumference (mm)
500/60 R 22.5 IMP	Agriterra 02	161 D	<b>AG 16.00 × 22.5</b> 15.00 × 22.5 16.00 × 22.5 17.00 × 22.5	524	1 172	543	3 547
560/45 R 22.5 IMP	Agriterra 02	152 D	<b>AG 16.00 × 22.5</b>	564	1 076	495	3 228
560/60 R 22.5 IMP	Agriterra 02	165 D	<b>AG 16.00 × 22.5</b> AG 20.00 × 22.5 16.00 × 22.5 17.00 × 22.5	567 607	1 247	568	3 743
600/50 R 22.5 IMP	Agriterra 02	163 D	<b>AG 20.00 × 22.5</b>	631	1 173	537	3 530
600/50 R 22.5 IMP	Agriterra 02	167 D	<b>AG 20.00 × 22.5</b>	631	1 173	537	3 530
710/45 R 22.5 IMP	Agriterra 02	165 D	<b>AG 24.00 × 22.5</b> AG 20.00 × 22.5	729	1 208	545	3 610
600/55 R 26.5 IMP	Agriterra 02	165 D	<b>AG 20.00 × 26.5</b>	626	1 335	585	4 033
650/55 R 26.5 IMP	Agriterra 02	169 D	<b>AG 20.00 × 26.5</b>	653	1 383	627	4 142

Agriterra 02



Agriterra 03



	Tyre load capacity (kg) at tyre pressure (bar)										Speed (km/h)
	1.0	1.2	1.6	2.0	2.4	2.8	3.2	3.6	4.0	5.0	
1 730	1 935	2 335	2 735	3 135	3 320	3 505	3 690	3 875	4 125	<b>4 625</b>	65
2 093	2 341	2 825	3 309	3 793	4 017	4 241	4 465	4 689	4 991	5 596	50
2 353	2 632	3 176	3 720	4 264	4 515	4 767	5 018	5 270	5 610	6 290	40
2 612	2 922	3 526	4 130	4 734	5 013	5 293	5 572	5 851	6 229	6 984	30
3 114	3 483	4 203	4 923	5 643	5 976	6 309	6 642	6 975	7 425	8 325	10
1 325	1 480	1 770	2 060	2 360	2 655	2 955	3 250	<b>3 550</b>			65
1 605	1 795	2 145	2 495	2 860	3 215	3 580	3 935	4 300			50
1 805	2 015	2 410	2 805	3 210	3 615	4 020	4 420	4 830			40
2 005	2 235	2 675	3 115	3 565	4 010	4 465	4 910	5 365			30
2 385	2 665	3 190	3 710	4 250	4 780	5 320	5 850	6 390			10
2 065	2 305	2 785	3 265	3 745	3 965	4 185	4 405	4 625	<b>5 150</b>		65
2 499	2 789	3 370	3 951	4 531	4 798	5 064	5 330	5 596	6 232		50
2 808	3 135	3 788	4 440	5 093	5 392	5 692	5 991	6 290	7 004		40
3 118	3 481	4 205	4 930	5 655	5 987	6 319	6 652	6 984	7 777		30
3 717	4 149	5 013	5 877	6 741	7 137	7 533	7 929	8 325	9 270		10
1 950	2 175	2 630	3 085	3 535	3 745	3 955	4 165	4 375	<b>4 875</b>		65
2 360	2 632	3 182	3 733	4 277	4 531	4 786	5 040	5 294	5 899		50
2 652	2 958	3 577	4 196	4 808	5 093	5 379	5 664	5 950	6 630		40
2 945	3 284	3 971	4 658	5 338	5 655	5 972	6 289	6 606	7 361		30
3 510	3 915	4 734	5 553	6 363	6 741	7 119	7 497	7 875	8 775		10
1 950	2 175	2 630	3 085	3 535	3 745	3 955	4 165	4 375	4 875	<b>5 450</b>	65
2 360	2 632	3 182	3 733	4 277	4 531	4 786	5 040	5 294	5 899	6 595	50
2 652	2 958	3 577	4 196	4 808	5 093	5 379	5 664	5 950	6 630	7 412	40
2 945	3 284	3 971	4 658	5 338	5 655	5 972	6 289	6 606	7 361	8 230	30
3 510	3 915	4 734	5 553	6 363	6 741	7 119	7 497	7 875	8 775	9 810	10
2 060	2 310	2 820	3 330	3 840	4 170	4 500	4 825	<b>5 150</b>			65
2 493	2 795	3 412	4 029	4 646	5 046	5 445	5 838	6 232			50
2 802	3 142	3 835	4 529	5 222	5 671	6 120	6 562	7 004			40
3 111	3 488	4 258	5 028	5 798	6 297	6 795	7 286	7 777			30
3 708	4 158	5 076	5 994	6 912	7 506	8 100	8 685	9 270			10
2 290	2 560	3 100	3 640	4 180	4 425	4 670	4 910	<b>5 150</b>			65
2 771	3 098	3 751	4 404	5 058	5 354	5 651	5 941	6 232			50
3 114	3 482	4 216	4 950	5 685	6 018	6 351	6 678	7 004			40
3 458	3 866	4 681	5 496	6 312	6 682	7 052	7 414	7 777			30
4 122	4 608	5 580	6 552	7 524	7 965	8 406	8 838	9 270			10
2 590	2 890	3 490	4 095	4 700	4 975	5 250	5 525	<b>5 800</b>			65
3 134	3 497	4 223	4 955	5 687	6 020	6 353	6 685	7 018			50
3 522	3 930	4 746	5 569	6 392	6 766	7 140	7 514	7 888			40
3 911	4 364	5 270	6 183	7 097	7 512	7 928	8 343	8 758			30
4 662	5 202	6 282	7 371	8 460	8 955	9 450	9 945	10 440			10

## Agriterra (continued)

### Technical data and load capacities

Tyre size	Tread pattern	Service description L/SS	Rims * (permitted)	Section width (mm)	Overall diameter (mm)	Loaded static radius (mm)	Rolling circumference (mm)
650/65 R 26.5 IMP	Agriterra 02	174 D	AG 20.00 × 26.5	675	1 516	683	4 527
710/50 R 26.5 IMP	Agriterra 02	170 D	AG 24.00 × 26.5 AG 20.00 × 26.5	737	1 388	628	4 189
800/45 R 26.5 IMP	Agriterra 02	174 D	AG 24.00 × 26.5 AG 28.00 × 26.5	770	1 394	628	4 163
680/60 R 30.5 IMP	Agriterra 03	176 D	AG 20.00 × 30.5	697	1 623	740	4 875
750/60 R 30.5 IMP	Agriterra 03	181 D	AG 24.00 × 30.5	792	1 672	755	4 998
850/50 R 30.5 IMP	Agriterra 02	182 D	AG 28.00 × 30.5	880	1 620	732	4 844

\* Further admissible rims on request

For intensive road transport at 65/50/40/30 km/h the pressure must be increased by 0.4 bar. Maximum inflation pressure should never be exceeded. All load values are valid for ground slopes up to and including 20% (1:5). When operating on slopes greater than 20%, please, contact the producer. Tubeless tyres – may be used with a tube.

Agriterra 02



Agriterra 03



	Tyre load capacity (kg) at tyre pressure (bar)										Speed (km/h)
	1.0	1.2	1.6	2.0	2.4	2.8	3.2	3.6	4.0	5.0	
2 670	3 000	3 660	4 320	4 980	5 410	5 840	6 270	<b>6 700</b>			65
3 231	3 630	4 429	5 227	6 026	6 546	7 066	7 587	8 107			50
3 631	4 080	4 978	5 875	6 773	7 358	7 942	8 527	9 112			40
4 032	4 530	5 527	6 523	7 520	8 169	8 818	9 468	10 117			30
4 806	5 400	6 588	7 776	8 964	9 738	10 512	11 286	12 060			10
2 690	3 000	3 620	4 240	4 860	5 145	5 430	5 715	<b>6 000</b>			65
3 255	3 630	4 380	5 130	5 881	6 225	6 570	6 915	7 260			50
3 658	4 080	4 923	5 766	6 610	6 997	7 385	7 772	8 160			40
4 062	4 530	5 466	6 402	7 339	7 769	8 199	8 630	9 060			30
4 842	5 400	6 516	7 632	8 748	9 261	9 774	10 287	10 800			10
2 670	3 000	3 660	4 320	4 980	5 410	5 840	6 270	<b>6 700</b>			65
3 231	3 630	4 429	5 227	6 026	6 546	7 066	7 587	8 107			50
3 631	4 080	4 978	5 875	6 773	7 358	7 942	8 527	9 112			40
4 032	4 530	5 527	6 523	7 520	8 169	8 818	9 468	10 117			30
4 806	5 400	6 588	7 776	8 964	9 738	10 512	11 286	12 060			10
3 170	3 540	4 280	5 020	5 760	6 095	6 430	6 765	<b>7 100</b>			65
3 840	4 285	5 180	6 075	6 970	7 375	7 785	8 190	8 595			50
4 315	4 815	5 825	6 830	7 835	8 290	8 745	9 205	9 660			40
4 790	5 350	6 465	7 585	8 700	9 205	9 710	10 220	10 725			30
5 710	6 375	7 705	9 040	10 370	10 975	11 575	12 180	12 780			10
3 680	4 110	4 970	5 830	6 690	7 080	7 470	7 860	<b>8 250</b>			65
4 453	4 973	6 014	7 054	8 095	8 567	9 039	9 511	9 983			50
5 005	5 590	6 759	7 929	9 098	9 629	10 159	10 690	11 220			40
5 557	6 206	7 505	8 803	10 102	10 691	11 280	11 869	12 458			30
6 624	7 398	8 946	10 494	12 042	12 744	13 446	14 148	14 850			10
3 400	3 820	4 660	5 500	6 340	6 880	7 420	7 960	<b>8 500</b>			65
4 114	4 622	5 639	6 655	7 671	8 325	8 978	9 632	10 285			50
4 624	5 195	6 338	7 480	8 622	9 357	10 091	10 826	11 560			40
5 134	5 768	7 037	8 305	9 573	10 389	11 204	12 020	12 835			30
6 120	6 876	8 388	9 900	11 412	12 384	13 356	14 328	15 300			10



### AR-01

Approved for high speed up to 80 km/h.  
Reduced fuel consumption.  
Prolonged working life.



### AR-02

High-grip thanks to robust lugs.  
Optimal pressure distribution.  
Balanced handling on and off the road.



### AR-03

Radial tyre designed for use on fastmoving self-loading forage boxes and trailers at speeds of up to 65 km/h. The larger footprint and low tyre pressure protect both grassland and soil. The tyre is also suitable for utility vehicles.



### AR-04

Radial traction tyre for use on grassland. Ideally suited for working on slopes. Very quiet running on roads at speeds of up to 65 km/h. High mileage performance through optimist tread pattern design.



### AR-05

The longitudinal and lateral structure of the tread pattern, combined with rounded tread shoulders, ensures low rolling resistance. The all-steel construction protects the tyre from damage. Approved for speeds of up to 100 km/h.



# AR – Agricultural radial tyres

with high load capacity and working speed

Main applications – Trailer radial tyres

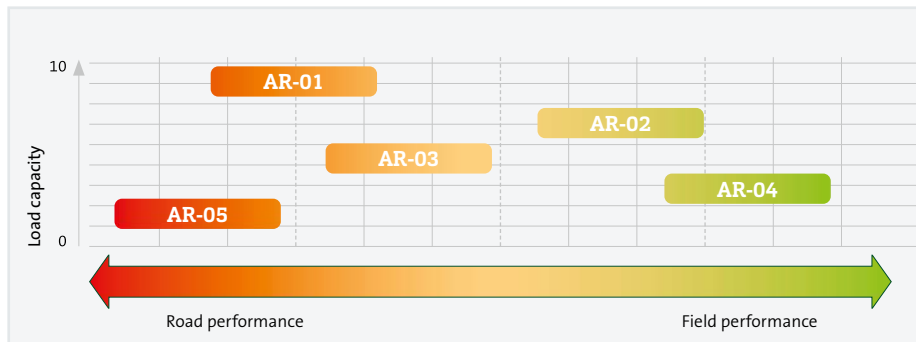

Trailer Radial Tyres



# Trailer Radial Tyres

## Technical data and load capacities

Tyre size	Tread pattern	Service description LI/SS	Rims * (permitted)	Section width (mm)	Overall diameter (mm)	Loaded static radius (mm)	Rolling circumference (mm)
<b>385/65 R 22.5</b> (15 R 22.5)	<b>AR-01</b>	161 F	<b>11.75 × 22.5</b>	389	1 072	485	3 248
<b>445/65 R 22.5</b> (18 R 22.5)	<b>AR-01</b>	169 F	<b>14.00 × 22.5</b>	454	1 150	514	3 484

Tyre size	Tread pattern	Service description LI/SS	Rims * (permitted)	Section width (mm)	Overall diameter (mm)	Loaded static radius (mm)	Rolling circumference (mm)
<b>460/65 R 22.5 IMP</b>	<b>AR-01</b>	168 A8 / 156 A8	<b>14.00 × 22.5</b> (15.00 × 22.5, 16.00 × 22.5)	450	1 170	550	3 456

\* Further admissible rims on request

For intensive road transport at 80/65/50/40/30 km/h the pressure must be increased by 0.4 bar. Maximum inflation pressure should never be exceeded. All load values are valid for ground slopes up to and including 20% (11°). When operating on slopes greater than 20%, please, contact the producer. Tubeless tyres – may be used with a tube.

AR-01



Tyre load capacity (kg) at tyre pressure (bar)											Speed (km/h)
4.0	4.5	5.0	5.5	6.0	6.5	7.0	7.5	8.0	8.5	9.0	
		2 600	2 800	3 000	3 200	3 400	3 600	3 850	4 100	<b>4 625</b>	80
		2 795	3 010	3 225	3 440	3 655	3 870	4 140	4 410	4 970	65
		2 910	3 135	3 360	3 585	3 810	4 030	4 310	4 590	5 180	50
		2 990	3 220	3 450	3 680	3 910	4 140	4 430	4 715	5 319	40
		3 250	3 500	3 750	4 000	4 250	4 500	4 815	5 125	5 781	30
		4 680	5 040	5 400	5 760	6 120	6 480	6 930	7 380	8 325	10
3 200	3 500	3 800	4 100	4 400	4 700	5 000	5 300	<b>5 800</b>			80
3 440	3 765	4 085	4 410	4 730	5 055	5 375	5 700	6 235			65
3 585	3 920	4 255	4 590	4 930	5 265	5 600	5 935	6 495			50
3 680	4 025	4 370	4 715	5 060	5 405	5 750	6 095	6 670			40
4 000	4 375	4 750	5 125	5 500	5 875	6 250	6 625	7 250			30
5 760	6 300	6 840	7 380	7 920	8 460	9 000	9 540	10 440			10

Tyre load capacity (kg) at tyre pressure (bar)										Speed (km/h)
0.8	1.2	1.6	2.0	2.4	2.8	3.2	3.6	4.0	5.0	
1 512	1 966	2 419	2 772	3 226	3 679	3 931	4 334	4 738	5 040	50
1 680	2 184	2 688	3 080	3 584	4 088	4 368	4 816	5 264	<b>5 600</b>	40
1 882	2 446	3 011	3 450	4 014	4 579	4 892	5 394	5 896	6 272	30
2 117	2 752	3 387	3 881	4 516	5 151	5 504	6 068	6 633	7 056	20
2 352	3 058	3 763	4 312	5 018	5 723	6 115	6 742	7 370	7 840	10

## Trailer Radial Tyres (continued)

### Technical data and load capacities

Tyre size	Tread pattern	Service description LI/SS	Rims * (permitted)	Section width (mm)	Overall diameter (mm)	Loaded static radius (mm)	Rolling circumference (mm)
440/50 R 17 IMP	AR-04 All terrain	135 D	14.00 × 17 13.00 × 17	441 431	873	393	2 605
500/50 R 17 IMP	AR-03 Universal service	149 D	16.00 × 17	502	933	425	2 800
560/60 R 22.5 IMP	AR-02	161 D	16.00 × 22.5 18.00 × 22.5	546	1 248	563	3 793

Tyre size	Tread pattern	Service description LI/SS	Rims * (permitted)	Tube Valve	Section width (mm)	Overall diameter (mm)	Loaded static radius (mm)	Rolling circumference (mm)
355/60 R 18 MPT	AR-05 AG trailer	142 J	11 × 18	(43 GS 16)** 10.5/80- /13.0/65-18; 355/60-18 T	352	890	398	2 650

\* Further admissible rims on request

\*\* Valve 50 GW optional

For intensive road transport at 100/80/65/50/40/30 km/h the pressure must be increased by 0.4 bar. Maximum inflation pressure should never be exceeded.

All load values are valid for ground slopes up to and including 20% (11°). When operating on slopes greater than 20%, please, contact the producer.

Tubeless tyres – may be used with a tube.



	Tyre load capacity (kg) at tyre pressure (bar)											Speed (km/h)
	0.8	1.0	1.2	1.6	2.0	2.4	2.8	3.2	3.6	4.0	5.0	
		870	950	1 100	1 430	1 575	1 715	2 040	<b>2 180</b>			65
	1 075	1 185	1 295	1 500	1 940	2 145	2 330	2 775	2 965			40
	1 190	1 315	1 435	1 665	2 155	2 380	2 585	3 080	3 290			30
	1 420	1 570	1 715	1 985	2 570	2 840	3 085	3 670	3 925			10
				1 150	1 505	1 680	1 845	2 200	2 665	-	<b>3 250</b>	65
				1 740	2 275	2 540	2 785	3 330	4 030	-	4 420	40
				1 930	2 530	2 825	3 090	3 695	4 470	-	4 910	30
				2 305	3 015	3 365	3 685	4 405	5 330	-	5 850	10
		2 065	2 305	2 785	3 265	3 745	3 965	4 185	4 405	<b>4 625</b>		65
		2 499	2 789	3 370	3 951	4 531	4 798	5 064	5 330	5 596		50
		2 808	3 135	3 788	4 440	5 093	5 392	5 692	5 991	6 290		40
		3 118	3 481	4 205	4 930	5 655	5 987	6 319	6 652	6 984		30
		3 717	4 149	5 013	5 877	6 741	7 137	7 533	7 929	8 325		10

	Tyre load capacity (kg) at tyre pressure (bar)								Speed (km/h)
	1.6	2.0	2.5	3.0	3.5	4.0	4.5	5.0	
	1 030	1 220	1 460	1 700	1 930	2 170	2 410	<b>2 650</b>	100
	1 120	1 320	1 580	1 840	2 090	2 350	2 610	2 880	65



## HCM

LOAD CAPACITY	██████████
TRACTION	██████████
SELF-CLEANING	██████████
HANDLING ON ROAD	██████████
COST EFFICIENCY	██████████

# High Capacity Municipal (HCM)

## Universal quiet running tyre for all terrains and applications



Particularly suitable for municipal and road maintenance tractors and equipment. Designed for **all-season use**.



**High durability** due to steel belted radial construction and unique design of tread pattern in the central part.



**Exceptional traction** characteristics due to more edges on the lugs. Different lugs width in shoulder for better traction in deeper terrain.



**Excellent self-cleaning** and **very good steering characteristics**.



**Low noise emission and vibration**, thanks to different length of pitches and their alignment along circumference.

Pitches with the same length

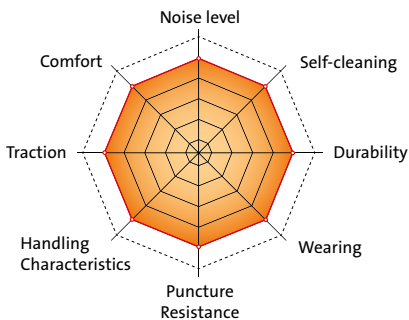

Pitches with different length

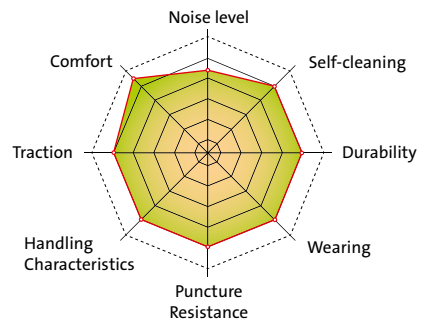

### Municipal tyres – reduction of noise emission

The same length of pitches – spectrum comprises periodic lines with high amplitude (all noise concentrated into multiple repeated basic frequency – formation of disturbing noise).

Different length of pitches and their alignment gives a spectrum with low amplitude – noise is divided into whole frequency range – reduction of disturbing noise.

# HCM

## Technical data and load capacities

Tyre size	Service description LI/SS	Rims * (permitted)	Section width (mm)	Overall diameter (mm)	Loaded static radius (mm)	Rolling circumference (mm)	Speed radius index
<b>400/80 R 24 IND</b>	149 A8 (144 D)	<b>DW 13</b> W 14 L DW 14 L	404	1 250	575	3 770	600
<b>440/80 R 24 IND</b>	154 A8 (149 D)	<b>DW 14 L</b> W 15 L DW 15 L	464	1 318	601	3 958	625
<b>400/80 R 28 IND</b>	151 A8 (146 D)	<b>DW 13</b> W 14 L DW 14 L	410	1 354	625	4 090	650
<b>440/80 R 28 IND</b>	156 A8 (151 D)	<b>DW 14 L</b> DW 15 L DW 16 L	455	1 413	647	4 252	675
<b>480/80 R 34 IND</b>	164 A8 (159 D)	<b>DW 15 L</b> DW 16 L DW 18 L	479	1 632	745	4 870	775
<b>480/80 R 38 IND</b>	166 A8 (161 D)	<b>DW 15 L</b> DW 16 L DW 18 L	507	1 738	800	5 243	825
<b>540/80 R 38 IND</b>	172 A8 (167 D)	<b>DW 18 L</b> DW 16 L	575	1 837	845	5 540	875

\* Further admissible rims on request

All load values are valid for ground slopes up to and including 20% (11°). When operating on slopes greater than 20%, please, contact the producer.  
Tubeless tyres – may be used with a tube.





HCM

	Tyre load capacity (kg) at tyre pressure (bar)						Speed (km/h)
	1.2	1.6	2.0	2.4	2.8	3.2	
	1 320	1 630	1 910	2 220	2 500	<b>2 800</b>	65
	1 424	1 757	2 060	2 394	2 697	3 030	50
	1 528	1 885	2 210	2 568	2 893	<b>3 250</b>	40
	1 589	1 960	2 298	2 670	3 008	3 380	30
	1 669	2 059	2 414	2 805	3 160	3 550	20
	1 913	2 361	2 768	3 215	3 622	4 070	10
	1 530	1 890	2 210	2 570	2 900	<b>3 250</b>	65
	1 650	2 040	2 390	2 780	3 130	3 510	50
	1 770	2 180	2 550	2 970	3 340	<b>3 750</b>	40
	1 840	2 270	2 660	3 090	3 480	3 900	30
	1 930	2 380	2 790	3 240	3 650	4 090	20
	2 210	2 730	3 190	3 710	4 180	4 690	10
	1 410	1 740	2 040	2 370	2 670	<b>3 000</b>	65
	1 530	1 880	2 210	2 560	2 890	3 240	50
	1 630	2 010	2 350	2 730	3 080	<b>3 450</b>	40
	1 690	2 090	2 450	2 840	3 200	3 590	30
	1 780	2 190	2 570	2 980	3 360	3 770	20
	2 040	2 510	2 940	3 420	3 850	4 320	10
	1 630	2 010	2 350	2 730	3 080	<b>3 450</b>	65
	1 760	2 170	2 540	2 950	3 320	3 730	50
	1 880	2 320	2 720	3 160	3 560	<b>4 000</b>	40
	1 960	2 420	2 830	3 290	3 710	4 160	30
	2 050	2 530	2 970	3 450	3 890	4 360	20
	2 350	2 900	3 400	3 950	4 450	5 000	10
	2 060	2 540	2 980	3 460	3 900	<b>4 375</b>	65
	2 230	2 750	3 220	3 740	4 210	4 730	50
	2 350	2 900	3 400	3 950	4 450	<b>5 000</b>	40
	2 450	3 020	3 540	4 110	4 630	5 200	30
	2 570	3 170	3 710	4 310	4 860	5 450	20
	2 940	3 630	4 250	4 940	5 570	6 250	10
	2 180	2 690	3 150	3 660	4 120	<b>4 625</b>	65
	2 350	2 900	3 400	3 950	4 450	5 000	50
	2 500	3 080	3 610	4 190	4 720	<b>5 300</b>	40
	2 600	3 210	3 760	4 370	4 920	5 520	30
	2 720	3 360	3 940	4 570	5 150	5 780	20
	3 120	3 850	4 510	5 240	5 910	6 630	10
	2 570	3 170	3 710	4 310	4 860	<b>5 450</b>	65
	2 768	3 416	4 005	4 653	5 242	5 890	50
	2 961	3 654	4 284	4 977	5 607	<b>6 300</b>	40
	3 083	3 805	4 461	5 182	5 838	6 560	30
	3 229	3 985	4 672	5 427	6 114	6 870	20
	3 704	4 570	5 358	6 225	7 013	7 880	10

Municipal, Agro-Industrial and Multipurpose Tyres



Longer service life

## TI-20

TRACTION	=====
SERVICE LIFE	=====
RESISTANCE	=====
SELF CLEANING	=====



Excellent traction

## TI-22

TRACTION	=====
SERVICE LIFE	=====
RESISTANCE	=====
SELF CLEANING	=====

# TI series – universal radial tyres

## For industrial and agricultural application

---

### TI-20

**New generation** of tread pattern.

Suitable for **construction, road and agricultural work.**

**Priority to traction.**

Designed for **muddy conditions.**

**Very good resistance to damage.**

### TI-22

**Good traction and effective self-cleaning properties.**

**Excellent durability.**

Suitable for backhoe loaders, wheeled loaders, telescopic handlers and similar vehicles for light service.

**Also suitable for agricultural application.**



# Agro-industrial TI

## Technical data and load capacities

Tyre size	Tread pattern Type	Rims (permitted)	New		Max. in service		Loaded static radius (mm)	Rolling circumference (mm)	
			Overall diameter (mm)	Section width (mm)	Overall diameter (mm)	Section width (mm)			
<b>340/80 R 18 IND</b>	TI-20 TL	11×18 (12×18, W 10×18, W 11×18)	1 001	343	1 023	360	449	2 993	
<b>460/70 R 24 IND</b> (17.5L R 24)	TI-22 TL	DW 14 L×24 (DW 15 L, DW 16 L, 14, 16, W 14 L)	1 254	455	1 280	478	559	3 700	
<b>480/80 R 26 IND</b>	TI-20 TL	DW 15 L×26 (DW 16 L×26)	1 428	500	1 458	525	640	4 250	
<b>440/70 R 28 IND</b>	AC 70 G TL	W 13 W 14 L W 15	1 348	435 445 455			604	4 027	
<b>440/80 R 28 IND</b>	TI-20 TL	DW 14 L×28 (DW 15 L×28)	1 415	441	1 445	466	640	4 235	

For intensive road transport at 65/50/40/30 km/h the pressure must be increased by 0.4 bar. Maximum inflation pressure should never be exceeded. All load values are valid for ground slopes up to and including 20% (11°). When operating on slopes greater than 20%, please, contact the producer.

TI-20



TI-22



	Service description LI/SS	Tyre load capacity (kg) at speed (km/h)						Tyre pressure (bar)	
		0	10	10 Cyclic	20	30	40		50
<b>143 A8</b>		3 760	2 045	2 450	1 780	1 700	1 635	1 570	2.0
		4 390	2 390	2 865	2 080	1 985	1 910	1 740	2.5
		5 015	2 725	3 270	2 375	2 270	2 180	1 985	3.0
		5 635	3 060	3 675	2 670	2 550	2 450	2 230	3.5
		6 265	3 405	4 090	2 970	2 835	<b>2 725</b>	2 480	<b>4.0</b>
<b>159 A8</b>		6 010	3 265	3 920	2 845	2 715	2 610	2 375	2.0
		7 020	3 815	4 580	3 330	3 175	3 055	2 780	2.5
		8 035	4 365	5 240	3 805	3 635	3 495	3 180	3.0
		9 050	4 920	5 900	4 290	4 090	3 935	3 580	3.5
		10 065	5 470	6 565	4 770	4 550	<b>4 375</b>	3 980	<b>4.0</b>
<b>160 A8</b>		7 073	3 844	4 613	3 352	3 198	3 075	2 798	2.0
		7 705	4 188	5 025	3 652	3 484	3 350	3 049	2.2
		8 165	4 438	5 325	3 870	3 692	3 550	3 231	2.4
		8 625	4 688	5 625	4 088	3 900	3 750	3 413	2.6
		9 200	5 000	6 000	4 360	4 160	4 000	3 640	2.8
		9 775	5 313	6 375	4 633	4 420	4 250	3 868	3.0
		10 350	5 625	6 750	4 905	4 680	<b>4 500</b>	4 095	<b>3.2</b>
<b>152 A8 (152 B)</b>		5 715	3 080	3 725	2 710	2 585	2 485	2 485	2.0
		6 125	3 300	3 995	2 900	2 770	2 665	2 665	2.2
		6 530	3 520	4 260	3 095	2 950	2 840	2 840	2.4
		6 940	3 740	4 525	3 290	3 135	3 020	3 020	2.6
		7 350	3 995	4 790	3 485	3 320	3 195	3 195	2.8
		7 755	4 220	5 060	3 675	3 505	3 370	3 370	3.0
<b>152 A8 (152 B)</b>		8 165	4 440	5 325	3 870	3 690	<b>3 550</b>	3 550	<b>3.2</b>
		6 440	3 500	4 200	3 052	2 912	2 800	2 548	2.0
		6 900	3 750	4 500	3 270	3 120	3 000	2 730	2.2
		7 245	3 938	4 725	3 434	3 276	3 150	2 867	2.4
		7 935	4 313	5 175	3 761	3 588	3 450	3 140	2.6
		8 395	4 563	5 475	3 979	3 796	3 650	3 322	2.8
		8 913	4 844	5 813	4 224	4 030	3 875	3 526	3.0
		9 200	5 000	6 000	4 360	4 160	<b>4 000</b>	3 640	<b>3.2</b>



## AC 70 G



# AC 70 G

## Universal radial multipurpose tyre (MPT)



**Stable, safe and comfortable running on the road**, thanks to a wide tread area and large lug overlap in the tread centre.



**Economical** thanks to low wear.



Tyres in the MPT range have a special casing and steel belt for **high speeds up to 90 km/h**.

---



## AC 70 G

### Technical data and load capacities

Tyre size	Service description L/SS	Rims * (permitted)	Section width (mm)	Overall diameter (mm)	Loaded static radius (mm)	Rolling circumference (mm)	
265/70 R 16 MPT	114 G	8	261	775	354	2 333	
		9	271				
		7	251				
285/80 R 16 MPT	126 G	10	308	866	370	2 540	
		9	298				
425/55 R 17 MPT	134 G	13	428	884	399	2 642	
325/70 R 18 MPT	125 G	10	321	918	421	2 765	
		11	331				
		9	311				
365/70 R 18 MPT	132 G	11	365	978	449	2 947	
		12	375				
		10	355				
275/80 R 20 MPT	131 G	9	274	966	446	2 890	
335/80 R 20 MPT	134 G	11	320	1 048	485	3 168	
		10	310				



AC 70 G



MPT-22



		Tyre load capacity (kg) at tyre pressure (bar)											Speed (km/h)	
		0.6	0.8	1.0	1.2	1.4	1.6	2.0	2.5	3.0	3.5	4.0		4.5
430	610		460	510	570	630	740	880	1 030	<b>1 180</b>				90
			490	560	620	680	800	960	1 120	1 280				65
			510	570	640	700	830	1 000	1 160	1 320				50
		460	520	590	650	720	850	1 020	1 190	1 360				40
		500	570	640	710	780	930	1 110	1 300	1 480				30
		820	920	1 030	1 130	1 330	1 600	1 860	2 120				10	
540	770		570	650	720	790	930	1 110	1 280	1 450	(4.25 bar)			90
			620	700	780	860	1 010	1 200	1 390	1 570	<b>1 700</b>			65
			640	720	800	880	1 040	1 240	1 430	1 620	1 900			50
		580	660	740	820	910	1 070	1 270	1 470	1 670	1 950			40
		630	720	810	900	990	1 170	1 380	1 600	1 810	2 120			30
	900	1 030	1 160	1 290	1 420	1 680	1 990	2 300	2 610	3 060			10	
740	1 060		780	880	980	1 080	1 280	1 550	1 830	<b>2 120</b>				90
			850	960	1 070	1 170	1 390	1 680	1 990	2 300				65
			880	990	1 100	1 210	1 430	1 740	2 050	2 370				50
		790	900	1 020	1 130	1 240	1 470	1 780	2 100	2 440				40
		860	980	1 110	1 230	1 350	1 600	1 940	2 290	2 650				30
		1 410	1 590	1 770	1 940	2 300	2 790	3 290	3 820				10	
620	890		660	740	820	900	1 060	1 260	1 460	<b>1 650</b>				90
			710	800	890	980	1 150	1 370	1 580	1 790				65
			740	830	920	1 010	1 200	1 410	1 630	1 850				50
		660	760	850	950	1 040	1 230	1 460	1 680	1 900				40
		720	820	930	1 030	1 130	1 340	1 570	1 820	2 060				30
	1 040	1 180	1 330	1 480	1 630	1 920	2 270	2 620	2 970				10	
740	1 060		790	890	980	1 080	1 280	1 520	1 760	<b>2 000</b>				90
			860	960	1 070	1 170	1 380	1 650	1 910	2 170				65
			880	990	1 100	1 210	1 440	1 700	1 970	2 240				50
		790	910	1 020	1 130	1 250	1 470	1 750	2 020	2 300				40
		860	990	1 110	1 230	1 360	1 600	1 900	2 200	2 500				30
	1 240	1 420	1 600	1 770	1 950	2 300	2 730	3 170	3 600				10	
560	810		600	670	750	820	970	1 160	1 340	1 510	1 690	(4.75 bar)		90
			650	730	810	890	1 060	1 250	1 450	1 640	1 830	<b>1 950</b>		65
			670	760	840	920	1 090	1 290	1 500	1 690	1 890	2 180		50
		600	690	780	860	950	1 120	1 330	1 540	1 730	1 940	2 240		40
		660	750	840	940	1 030	1 220	1 440	1 670	1 890	2 110	2 440		30
	940	1 080	1 210	1 350	1 480	1 750	2 080	2 400	2 720	3 040	3 510		10	
760	1 100		810	920	1 020	1 120	1 330	1 590	1 870	<b>2 120</b>				90
			880	990	1 110	1 220	1 440	1 730	2 010	2 300				65
			910	1 030	1 140	1 250	1 480	1 780	2 080	2 380				50
		820	940	1 050	1 170	1 290	1 520	1 820	2 130	2 440				40
		890	1 020	1 150	1 270	1 400	1 650	1 990	2 320	2 650				30
	1 280	1 460	1 650	1 830	2 010	2 380	2 870	3 340	3 820				10	

## AC 70 G (continued)

### Technical data and load capacities

Tyre size	Service description L/SS	Rims * (permitted)	Section width (mm)	Overall diameter (mm)	Loaded static radius (mm)	Rolling circumference (mm)	
<b>375/70 R 20 MPT</b>	136 G	<b>11</b> 12 10	390 400 380	1 034	471	3 107	
<b>405/70 R 20 MPT</b>	136 G	<b>11</b> 13	405 425	1 065	485	3 225	
<b>425/75 R 20 MPT</b>	148 G	<b>13</b> 11	441 421	1 148	521	3 440	
<b>445/65 R 22.5 MPT<sup>1)</sup></b>	160 G	<b>14</b> 13	450 440	1 172	536	3 525	
<b>405/70 R 24 MPT</b>	149 G	<b>13</b>	419	1 166	541	3 530	
<b>445/70 R 24 MPT</b>	151 G	<b>W 13</b> W 14 L W 12	435 445 425	1 248	561	3 708	
<b>445/70 R 24 MPT<sup>2)</sup></b> (17.5L R 24)	151 G	<b>DW 15 L</b>	465	1 255	573	3 765	

AC 70 G



MPT-22



Tyre load capacity (kg) at tyre pressure (bar)													Speed (km/h)
0.6	0.8	1.0	1.2	1.4	1.6	2.0	2.5	3.0	3.5	4.0	4.5	6.0	
		860	970	1 080	1 180	1 400	1 630	1 850	2 050	<b>2 240</b>			90
		930	1 050	1 170	1 280	1 520	1 770	2 000	2 220	2 430			65
		960	1 090	1 210	1 330	1 570	1 820	2 070	2 300	2 510			50
	870	990	1 110	1 240	1 360	1 610	1 870	2 120	2 360	2 580			40
810	940	1 080	1 210	1 350	1 480	1 750	2 040	2 310	2 560	2 800			30
1 160	1 360	1 550	1 740	1 940	2 130	2 520	2 930	3 320	3 690	4 030			10
		970	1 090	1 210	1 340	1 580	1 820	2 040	<b>2 240</b>				90
		1 050	1 190	1 320	1 450	1 710	1 970	2 210	2 430				65
		1 090	1 220	1 360	1 500	1 770	2 040	2 280	2 510				50
	980	1 120	1 260	1 400	1 540	1 820	2 090	2 350	2 580				40
910	1 060	1 210	1 370	1 520	1 670	1 970	2 270	2 550	2 800				30
1 310	1 530	1 750	1 970	2 190	2 400	2 840	3 270	3 670	4 030				10
		1 120	1 260	1 400	1 540	1 810	2 150	2 490	2 820	<b>3 150</b>			90
		1 210	1 360	1 510	1 670	1 970	2 340	2 700	3 060	3 420			65
		1 250	1 410	1 560	1 720	2 030	2 410	2 790	3 160	3 530			50
	1 120	1 280	1 440	1 610	1 770	2 090	2 480	2 860	3 240	3 620			40
1 050	1 220	1 400	1 570	1 740	1 920	2 270	2 690	3 110	3 530	3 940			30
1 510	1 760	2 010	2 260	2 510	2 760	3 270	3 880	4 480	5 080	5 670			10
		1 270	1 430	1 580	1 740	2 060	2 410	2 750	3 075	3 390	3 690	<b>4 500</b>	90
		1 370	1 550	1 720	1 890	2 235	2 615	2 985	3 340	3 675	4 000	4 885	65
		1 420	1 600	1 770	1 950	2 305	2 700	3 080	3 445	3 795	4 130	5 040	50
	1 280	1 460	1 640	1 820	2 005	2 365	2 770	3 165	3 540	3 900	4 240	5 175	40
1 190	1 390	1 580	1 780	1 980	2 175	2 575	3 015	3 440	3 845	4 235	4 610	5 625	30
1 710	2 000	2 280	2 570	2 850	3 135	3 705	4 340	4 950	5 540	6 100	6 640	8 100	10
		1 050	1 180	1 320	1 450	1 710	2 030	2 340	2 650	2 950	<b>3 250</b>		90
		1 140	1 290	1 430	1 570	1 860	2 200	2 540	2 870	3 200	3 530		65
		1 180	1 330	1 470	1 620	1 920	2 270	2 620	2 960	3 300	3 640		50
	1 060	1 210	1 360	1 510	1 670	1 970	2 330	2 690	3 040	3 390	3 740		40
990	1 150	1 320	1 480	1 650	1 810	2 140	2 530	2 920	3 310	3 690	4 060		30
1 420	1 660	1 900	2 130	2 370	2 610	3 080	3 650	4 210	4 760	5 310	5 850		10
		1 220	1 370	1 520	1 670	1 980	2 440	2 930	<b>3 450</b>				90
		1 320	1 490	1 650	1 820	2 150	2 650	3 180	3 740				65
		1 370	1 540	1 710	1 880	2 220	2 740	3 290	3 860				50
	1 230	1 400	1 580	1 750	1 930	2 280	2 810	3 370	3 970				40
1 140	1 330	1 520	1 710	1 900	2 090	2 480	3 050	3 670	4 310				30
1 650	1 920	2 190	2 470	2 740	3 020	3 560	4 400	5 280	6 210				10
		1 200	1 345	1 500	1 635	1 930	2 400	2 650	3 010	3 380	(4.25 bar)		90
		1 248	1 399	1 560	1 700	2 007	2 496	2 756	3 130	3 515	<b>3 450</b>		80
		1 284	1 439	1 605	1 749	2 065	2 568	2 836	3 221	3 617	3 692		70
		1 344	1 506	1 680	1 831	2 162	2 688	2 968	3 371	3 786	3 864		50
		1 380	1 547	1 725	1 880	2 220	2 760	3 050	3 470	3 880	3 970		40
		2 150	2 421	2 700	2 943	3 470	4 320	4 770	5 430	6 080	6 210		10

## AC 70 G (continued)

### Technical data and load capacities

Tyre size	Service description L/SS	Rims * (permitted)	Section width (mm)	Overall diameter (mm)	Loaded static radius (mm)	Rolling circumference (mm)
<b>495/70 R 24 MPT</b>	155 G	<b>W 15 L</b> W 16 L W 14 L	493 503 483	1 313	582	3 908
<b>495/70 R 30 MPT</b>	147 G	<b>W 15 L</b> W 16 L W 14 L	486 496 476	1 462	666	4 325

\* Further admissible rims on request

<sup>1)</sup> Tread Pattern AC 70 +

<sup>2)</sup> Tread Pattern MPT-22

Load values for 0.6 bar are for calculating dual and triple load values only.

30 km/h (up to 40 km/h) load values also apply for low-speed high-torque field work.

For plowing with single driven tyres in the furrow, a minimum inflation pressure of 0.8 bar is required.

For intensive road transport at 90/65/50/40/30 km/h the pressure must be increased by 0.4 bar. Maximum inflation pressure should never be exceeded.

All load values are valid for ground slopes up to and including 20% (11°). When operating on slopes greater than 20%, please, contact the producer.

Tubeless tyres – may be used with a tube.

AC 70 G



MPT-22



		Tyre load capacity (kg) at tyre pressure (bar)										Speed (km/h)		
		0.6	0.8	1.0	1.2	1.4	1.6	2.0	2.5	3.0	3.5		4.0	4.5
1 350	1 450	1 440	1 620	1 800	1 980	2 340	2 840	3 250	<b>3 875</b>					90
		1 560	1 760	1 950	2 150	2 540	3 080	3 630	4 210					65
		1 620	1 810	2 020	2 220	2 620	3 180	3 750	4 340					50
		1 660	1 860	2 070	2 280	2 690	3 260	3 850	4 460					40
1 940	2 270	1 800	2 020	2 250	2 470	2 920	3 550	4 190	4 850					30
		2 590	2 920	3 240	3 560	4 210	5 110	6 030	6 980					10
1 490	1 600	1 590	1 790	1 990	2 180	2 580	<b>3 075</b>							90
		1 720	1 940	2 160	2 370	2 800	3 340							65
		1 780	2 000	2 220	2 450	2 890	3 450							50
		1 830	2 060	2 280	2 510	2 970	3 540							40
2 150	2 500	1 990	2 230	2 480	2 730	3 230	3 850							30
		2 860	3 220	3 580	3 930	4 650	5 540							10



Excellent traction



### MPT-01

Tread pattern with very good traction and self-cleaning properties. Suitable above all for loader applications.



Excellent traction



### TD-10

Lugged tread pattern for powered axle.



Excellent traction



### TR-01 (R-4)

Excellent traction pattern, suitable for industrial and agricultural application.



Excellent traction



### TI-05 (R-4)

Robust industrial tread pattern with excellent traction properties.



Excellent traction



### TD-03 (R-1)

Pattern suitable above all for harder conditions due to optimised number of lugs.

# Agro-industrial diagonal tyres

## Robust and durable tyres for various work

Tyre size	MPT-01	TD-10	TR-01	TI-05	TD-03
280/80-18 MPT	•				
275/80-18 MPT		•			
12.5-18 MPT	•				
320/80-18		•			
275/80-20 MPT		•			
12.5-20 MPT	•				
335/80-20 MPT		•			
360/80-20		•			
365/80-20 MPT		•			
400/70-20		•	•		
405/70-20 MPT	•				
15.5/80-24		•	•		
400/80-24 IND				•	
405/70-24 MPT	•				
16.5/85-24		•			
17.5L-24			•		
460/70-24 IND			•	•	
19.5L-24 IND				•	
500/70-24 IND				•	
16.9-30 IND					•



# Agro-industrial diagonal

## Technical data and load capacities

Tyre size	Tread pattern	Type	Rims * (permitted)	Tube Flap	Section width (mm)	Overall diameter (mm)	Loaded static radius (mm)	Rolling circumference (mm)	
<b>280/80 - 18 MPT</b> (10.5 - 18 MPT)	MPT-01	TL	9×18	10 - 18	270	905	419	2 660	
<b>280/80 - 18 MPT</b> (10.5 - 18 MPT)	MPT-01	TL	9×18	10 - 18	270	905	419	2 660	
<b>275/80 - 18 MPT</b> (10.5 - 18 MPT)	TD-10	TL	9×18	-	278	911	422	2 730	
<b>340/80 - 18 MPT</b> (12.5 - 18 MPT)	MPT-01	TL	11×18 (9×18)	12.5 - 18 12 - 18HS	325	990	455	2 910	
<b>340/80 - 18 MPT</b> (12.5 - 18 MPT)	MPT-01	TL	11×18 (9×18)	12.5 - 18 12 - 18HS	325	990	455	2 910	
<b>340/80 - 18 MPT</b> (12.5 - 18 MPT)	MPT-01	TL	11×18 (9×18)	12.5 - 18 12 - 18HS	325	990	455	2 910	
<b>275/80 - 20 MPT</b> (10.5 - 20 MPT)	TD-10	TL	9×20	-	278	948	444	2 805	
<b>275/80 - 20 MPT</b> (10.5 - 20 MPT)	TD-10	TL	9×20	-	278	948	444	2 805	
<b>335/80 - 20 MPT</b> (12.5 - 20 MPT)	TD-10	TL	11×20 11 - 20 SDC	-	340	1 044	480	3 055	
<b>340/80 - 20 MPT</b> (12.5 - 20 MPT)	MPT-01	TL	11×20 (11;12-20SDC)	-	325	1 040	480	3 060	
<b>340/80 - 20 MPT</b> (12.5 - 20 MPT)	MPT-01	TL	11×20 (11;12-20SDC)	-	325	1 040	480	3 060	
<b>365/80 - 20 MPT</b>	TD-10	TL	11×20 11 - 20 SDC	-	360	1 092	503	3 215	



MPT-01



TD-10



TR-01



	Ply rating	Service description LI/SS	Tyre load capacity (kg) at speed (km/h)						Tyre pressure (bar)		
			10	20	30	40	50	70			
	10 PR	130 B	2 368	1 835	1 687	1 628	1 480		2.25		
			2 464	1 910	1 756	1 694	1 540		2.50		
			2 576	1 996	1 835	1 771	1 610		2.75		
			2 720	2 108	1 938	1 870	1 700		3.00		
			2 848	2 207	2 029	1 958	1 780		3.25		
			2 952	2 288	2 103	2 030	1 845		3.50		
			3 040	2 356	2 166	2 090	<b>1 900</b>		<b>3.75</b>		
	16 PR	140 B	3 280	2 540	2 330	2 250	2 050		4.50		
			3 520	2 720	2 500	2 420	2 200		5.00		
			3 760	2 910	2 670	2 580	2 350		5.50		
			4 000	3 100	2 850	2 750	<b>2 500</b>		<b>6.00</b>		
	10 PR	126 E	1 550	1 205	1 075	990	965		1.50		
			1 910	1 485	1 325	1 220	1 185	1 060	2.00		
			2 900	2 255	2 015	1 850	1 805	1 610	3.50		
			3 060	2 380	2 125	1 955	1 905	<b>1 700</b>	<b>3.75</b>		
			2 416	1 872	1 721	1 661	1 510		1.75		
	10 PR	132 B	2 608	2 021	1 858	1 793	1 630		2.00		
			2 784	2 158	1 984	1 914	1 740		2.25		
			2 976	2 306	2 120	2 046	1 860		2.50		
			3 104	2 406	2 212	2 134	1 940		2.75		
			3 248	2 517	2 314	2 233	<b>2 030</b>		<b>3.00</b>		
			12 PR	135 B	3 368	2 610	2 400	2 316	2 105		3.25
					3 488	2 703	2 485	2 398	<b>2 180</b>		<b>3.50</b>
	16 PR	145 B	3 875	3 000	2 760	2 660	2 420		4.00		
			4 255	3 300	3 030	2 925	2 660		4.50		
			4 640	3 595	3 300	3 190	<b>2 900</b>		<b>5.00</b>		
	8 PR	123 E	1 910	1 590	1 325	1 220	1 185	1 060	1.75		
			2 105	1 755	1 465	1 345	1 310	1 170	2.00		
			2 520	2 100	1 750	1 610	1 570	1 400	2.50		
			2 790	2 325	1 940	1 785	1 735	<b>1 550</b>	<b>3.00</b>		
	12 PR	131 E	3 095	2 580	2 150	1 980	1 925	1 720	3.50		
			3 375	2 810	2 345	2 155	2 100	1 875	4.00		
			3 510	2 925	2 440	2 245	2 185	<b>1 950</b>	<b>4.25</b>		
	10 PR	129 E	2 465	2 055	1 710	1 575	1 535	1 370	1.75		
			2 720	2 265	1 890	1 735	1 690	1 510	2.00		
			3 060	2 550	2 125	1 955	1 905	1 700	2.50		
			3 330	2 775	2 310	2 130	2 070	<b>1 850</b>	<b>3.00</b>		
	10 PR	133 B	3 216	2 492	2 291	2 211	2 010		2.75		
			3 344	2 592	2 383	2 299	<b>2 090</b>		<b>3.00</b>		
	12 PR	136 B	3 488	2 703	2 485	2 398	2 180		3.25		
			3 616	2 802	2 576	2 486	<b>2 260</b>		<b>3.50</b>		
	10 PR	132 E	2 810	2 340	1 950	1 795	1 750	1 560	1.75		
			3 115	2 595	2 160	1 990	1 940	1 730	2.00		
			3 600	3 000	2 500	2 300	2 240	<b>2 000</b>	<b>2.50</b>		

## Agro-industrial diagonal (continued)

### Technical data and load capacities

Tyre size	Tread pattern	Type	Rims * (permitted)	Tube Flap	Section width (mm)	Overall diameter (mm)	Loaded static radius (mm)	Rolling circumference (mm)
<b>400/70-20</b>	TR-01	TL	13SDC × 20	-	404	1 090	490	3 210
<b>405/70-20 MPT</b> (16/70-20)	MPT-01	TL	13 × 20 (13-20SDC)		407	1 076	495	3 165
<b>405/70-20 MPT</b> (16/70-20)	MPT-01	TL	13 × 20 (13-20SDC)		407	1 076	495	3 165
<b>15.5/80-24</b>	TR-01	TL	W12 × 24 (W13 × 24) (W14L × 24)	-	394	1 269	585	3 730
<b>15.5/80-24</b>	TR-01	TL	W12 × 24 (W13 × 24, W14L × 24)	-	394	1 269	585	3 730
<b>15.5/80-24</b>	TR-01	TL	W12 × 24 (W13 × 24) (W14L × 24)	-	394	1 269	585	3 730
<b>405/70-24 MPT</b> (16/70-24)	MPT-01	TL	13 × 24 (13-24SDC)	16/70-24	407	1 178	545	3 465
<b>17.5L-24</b>	TR-01	TL	W15L × 24	-	445	1 241	580	3 650

<sup>01</sup> Reinforced version also available (REINFORCED)

For Non-standard version, please contact a producer.

These tyres are for normal agricultural use and not for continuous highway service.

MPT-01



TD-10



TR-01



	Ply rating	Service description LI/SS	Tyre load capacity (kg) at speed (km/h)						Tyre pressure (bar)
			10	20	30	40	50	70	
	4 PR	50 B	3 040	3 735	2 420	2 175	1 975	2.00	
			3 580	3 225	2 850	2 560	2 325	2.50	
			4 120	3 710	3 280	2 945	2 675	3.00	
			4 660	4 195	3 710	3 330	3 025	3.50	
			5 160	4 645	4 100	3 685	<b>3 350</b>	<b>4.00</b>	
	14 PR	149 B	3 840	2 976	2 736	2 640	2 400	2.25	
			4 120	3 193	2 936	2 833	2 575	2.50	
			4 656	3 608	3 317	3 201	2 910	3.00	
			4 928	3 819	3 511	3 388	3 080	3.25	
			5 200	4 030	3 705	3 575	<b>3 250</b>	<b>3.50</b>	
	16 PR	152 B	5 440	4 216	3 876	3 740	3 400	3.75	
			5 680	4 402	4 047	3 905	<b>3 550</b>	<b>4.00</b>	
	12 PR	154/142 A8	3 025	2 720	2 400	2 160	1 945	2.00	
			3 185	2 865	2 525	2 275	2 050	2.25	
			3 305	2 975	2 650	2 360	2 125	2.50	
			3 500	3 150	2 775	2 500	2 250	2.75	
			3 710	3 340	2 900	<b>2 650</b>	2 385	<b>3.00</b>	
	14 PR (1)	156/144 A8	3 815	3 435	3 025	2 725	2 455	3.25	
			3 920	3 530	3 150	<b>2 800</b>	2 520	<b>3.50</b>	
	16 PR	159/147 A8	4 115	3 700	3 290	2 938	2 645	3.75	
			4 305	3 875	3 445	<b>3 075</b>	2 770	<b>4.10</b>	
		163/151 A8	4 480	4 030	3 585	3 200	2 880	4.25	
			4 655	4 190	3 725	3 325	2 995	4.50	
			4 830	4 345	3 865	<b>3 450</b>	3 105	<b>4.75</b>	
	14 PR	152 B	5 360	4 154	3 819	3 685	3 350	3.75	
			5 680	4 402	4 047	3 905	<b>3 550</b>	<b>4.00</b>	
	10 PR	-/144 A8	2 500	2 250	2 000	1 785	1 605	1.10	
			2 800	2 520	2 240	2 000	1 800	1.30	
			3 100	2 790	2 480	2 215	1 995	1.50	
			3 400	3 060	2 720	2 430	2 185	1.70	
			3 705	3 335	2 960	2 645	2 380	2.00	
			3 920	3 530	3 135	<b>2 800</b>	2 520	<b>2.20</b>	

## Agro-industrial diagonal (continued)

### Technical data and load capacities

Tyre size	Tread pattern Type	Rims (permitted)	New		Max. in service		Loaded static radius (mm)	Rolling circumference (mm)	
			Overall diameter (mm)	Section width (mm)	Overall diameter (mm)	Section width (mm)			
<b>400/80 - 24 IND</b> (15.5/80 - 24)	TI-05 TL	DW 13×24 (DW 14 L×24) (13×24, 14×24) (TW 14 L×24)	1 250	404	1 294	436	573	3 688	
<b>460/70 - 24 IND</b> (17.5L - 24)	TI-05 TL	DW 14 L×24 (DW 15 L, DW 16 L, 14, 16, TW 14 L)	1 250	455	1 300	494	580	3 660	
<b>460/70 - 24 IND</b> (17.5L - 24)	TR-01 TL	DW 14 L×24 (DW 15 L, DW 16 L, 14, 16, TW 14 L)	1 254	455	1 300	494	565	3 700	
<b>19.5 L - 24 IND</b>	TI-05 TL	DW 16 L×24	1 314	495	1 356	535	610	3 865	
<b>500/70 - 24 IND</b> (19.5L - 24)	TI-05 TL	DW 16 L×24 (DW 15 L×24) (W 15 L×24) (W 16 L×24)(16×24)	1 310	503	1 360	528	589	3 865	
<b>16.9 - 30 IND</b>	TD-03 TL	W 15 L×30 (W 14 L×30)	1 485	429	1 530	463	695	4 380	



Service description LI/SS	Ply rating	Tyre load capacity (kg) at speed (km/h)								Tyre pressure (bar)
		Static	10	10 cyclic	20	30	40	50		
162 A8	-	5 975	3 245	3 895	2 830	2 700	2 595	2 365	2.00	
		6 800	3 695	4 435	3 220	3 075	2 956	2 690	2.50	
		7 625	4 145	4 975	3 615	3 450	3 315	3 020	3.00	
		8 450	4 590	5 510	4 005	3 820	3 675	3 340	3.50	
		9 275	5 040	6 050	4 395	4 195	4 030	3 670	4.00	
		10 100	5 490	6 585	4 785	4 565	4 390	3 995	4.50	
		10 925	5 940	7 125	5 180	4 940	<b>4 750</b>	4 325	<b>5.00</b>	
159 A8	-	6 555	3 565	4 275	3 105	2 965	2 850	2 595	2.00	
		7 430	4 040	4 845	3 520	3 360	3 230	2 940	2.50	
		8 305	4 515	5 415	3 935	3 755	3 610	3 285	3.00	
		9 175	4 990	5 985	4 350	4 150	3 990	3 630	3.50	
		10 065	5 470	6 565	4 770	4 550	<b>4 375</b>	3 980	<b>4.00</b>	
159 A8	-	6 555	3 565	4 275	3 105	2 965	2 850	2 595	2.00	
		7 430	4 040	4 845	3 520	3 360	3 230	2 940	2.50	
		8 305	4 515	5 415	3 935	3 755	3 610	3 285	3.00	
		9 175	4 990	5 985	4 350	4 150	3 990	3 630	3.50	
		10 065	5 470	6 565	4 770	4 550	<b>4 375</b>	3 980	<b>4.00</b>	
151 A8	12 PR	4 510	2 450	2 940	2 140	2 040	1 960	1 785	1.10	
		5 095	2 770	3 325	2 415	2 305	2 215	2 015	1.30	
		5 680	3 090	3 705	2 690	2 570	2 470	2 250	1.50	
		6 270	3 405	4 090	2 970	2 835	2 725	2 480	1.70	
		7 075	3 845	4 615	3 350	3 200	3 075	2 800	1.90	
		7 510	4 080	4 900	3 560	3 395	3 265	2 970	2.10	
		7 935	4 315	5 175	3 760	3 590	<b>3 450</b>	3 140	<b>2.30</b>	
		7 705	4 185	5 022	3 650	3 485	3 350	3 050	2.00	
164 A8	-	8 650	4 700	5 640	4 100	3 910	3 760	3 425	2.50	
		9 600	5 220	6 260	4 550	4 340	4 175	3 800	3.00	
		10 550	5 735	6 880	5 000	4 770	4 585	4 175	3.50	
		11 500	6 250	7 500	5 450	5 200	<b>5 000</b>	4 550	<b>4.00</b>	
		4 740	2 575	3 090	2 245	2 140	2 060	1 870	1.10	
		5 245	2 850	3 420	2 485	2 370	2 280	2 070	1.30	
154 A8	14 PR	5 750	3 125	3 750	2 725	2 600	2 500	2 275	1.50	
		6 325	3 435	4 125	2 995	2 860	2 750	2 500	1.70	
		7 095	3 855	4 625	3 360	3 205	3 085	2 805	2.00	
		7 475	4 060	4 875	3 540	3 380	3 250	2 955	2.20	
		7 995	4 340	5 210	3 785	3 610	3 475	3 160	2.50	
		8 315	4 515	5 420	3 940	3 755	3 615	3 285	2.70	
		8 625	4 685	5 625	4 085	3 900	<b>3 750</b>	3 410	<b>2.90</b>	
		5 750	3 125	3 750	2 725	2 600	2 500	2 275	1.50	
		6 325	3 435	4 125	2 995	2 860	2 750	2 500	1.70	
		7 095	3 855	4 625	3 360	3 205	3 085	2 805	2.00	

Municipal, Agro-Industrial and Multipurpose Tyres

## Agro-industrial diagonal (TD-10)

### Technical data and load capacities

Tyre size	Tread pattern	Tube Flap	Rim * (permitted)	Section width (mm)	Overall diameter (mm)	Loaded static radius (mm)	Rolling circumference (mm)
<b>320/80 - 18</b> (repl. 12.5/80 - 18)	TD-10 TL	12.5/14.5/80 - 18 T 38G16 S	<b>9 × 18</b>	308	1 000	443 ⊕ 430 ⊕+	3 025 ⊕ 3 015 ⊕+
<b>360/80 - 20</b> (repl. 14.5/75 - 20)	TD-10 TL	16/70 - 20; 335/80 - 20; 375/405/70 - 20 47GW S	<b>11 × 20</b> 12 × 20	360 370	1 092	492 ⊕ 485 ⊕+	3 205 ⊕ 3 200 ⊕+
<b>400/70 - 20</b> (repl. 16/70 - 20)	TD-10 TL	16/70 - 20; 335/80 - 20; 375/405/70 - 20 47GW S	<b>13 × 20</b> 14 × 20	412 422	1 106	503 ⊕ 493 ⊕+	3 337 ⊕ 3 325 ⊕+
<b>15.5/80 - 24</b>	TD-10 TL	14.9/16.9(13/14) - 24 T 47GW S	<b>W 13</b> W 14 W 12	376 387 365	1 270	586 ⊕ 575 ⊕+	3 841 ⊕ 3 820 ⊕+
<b>16.5/85 - 24</b>	TD-10 TL	14.9/16.9(13/14) - 24 T 47GW S	<b>W 13</b> W 15 L W 14 L	413 435 424	1 338	590 ⊕ 580 ⊕+	4 032 ⊕ 4 010 ⊕+

For Non-standard version, please contact a producer.

These tyres are for normal agricultural use and not for continuous highway service.

- ⊕ – drive wheel  
⊕+ – free rolling wheel

TD-10



	Service description		Tyre load capacity (kg) at tyre pressure (bar)										Speed (km/h)
	PR	LI/SS	1.0	1.5	1.8	2.0	2.3	2.5	2.8	3.1	3.4	3.9	
<b>10 PR</b>	126 A8 ⊕	900	1 185	1 330	1 440	1 500	1 540	1 570	<b>1 700</b>				40
	139 A8 ⊕→	1 290	1 700	1 900	2 060	2 145	2 200	2 315	<b>2 430</b>				40
<b>8 PR</b>	128 A8 ⊕	1 140	1 480	1 600	1 630	<b>1 800</b>							40
	141 A8 ⊕→	1 630	2 135	2 290	2 330	<b>2 575</b>							40
<b>14 PR</b>	142 A8 ⊕	1 190	1 565	1 750	1 890	2 110	2 260	2 455	<b>2 650</b>				40
	154 A8 ⊕→	1 700	2 235	2 500	2 710	3 020	3 230	3 490	<b>3 750</b>				40
<b>16 PR</b>	152 A6 ⊕	1 290	1 690	1 930	2 100	2 340	2 500	2 700	2 900	3 160	<b>3 550</b>		30
	164 A6 ⊕→	1 830	2 405	2 750	2 980	3 320	3 550	3 840	4 125	4 350	<b>4 875</b>		30
<b>14 PR</b>	153 A6 ⊕	1 700	2 225	2 540	2 650	2 800	2 900	3 135	3 370	<b>3 650</b>			30
	165 A6 ⊕→	2 400	3 150	3 600	3 750	3 955	4 090	4 420	4 750	<b>5 150</b>			30



## AF-01



## TL-01





# AF-01 and TL-01

## Heavy-duty agroforestry tractor tyres for the toughest conditions

**High resistance to puncture** due to reinforced construction and durable tread compound.

**Great traction** due to specially developed tread pattern.

**Very good self-cleaning properties** for better grip and less slip.

**High load capability** and transport properties.

**Suitable for a wide range of uses in forestry** and for heavy agricultural work.

### Puncture resistance comparison

Thanks to reinforced construction, the radial force needed to puncture the AF-01 tyre is 35 % higher than in the case of the standard tractor drive tyre Mitas TD-19.

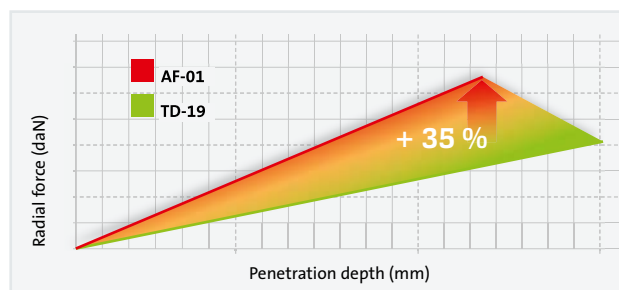

### Radial force needed to puncture AF-01 and TD-19

Compared tyres:  
Mitas 460/85 - 34 (18.4 - 34)  
AF-01 and Mitas  
18.4 - 34 TD-19



# Agro Forestry Tyres AF-01, TL-01

## Technical data and load capacities

Tyre size	Service description L/SS	Tread pattern	Rims * (permitted)	Tube	Section width (mm)	Overall diameter (mm)	Loaded static radius (mm)	Rolling circumference (mm)	Speed radius index	Water 75% (l)
<b>380/85 - 24</b> (14.9 - 24)	137 A8 (134 B)	AF-01 TT	<b>W 13</b> W 11 W 12	14.9 - 24	377 357 367	1 244	565	3 748	600	150
<b>380/85 - 28</b> (14.9 - 28)	139 A8 (136 B)	AF-01 TT	<b>W 13</b> W 11 W 12	14.9 - 28	386 366 376	1 354	612	4 056	650	190
<b>16.9 - 30</b>	12 PR	TL-01 TT	<b>W 15 L</b> W 14 L	16.9 - 30	429	1 485	685	4 390	700	240
<b>420/85 - 34</b> (16.9 - 34)	147 A8 (144 B)	AF-01 TT	<b>W 13</b> W 14 L W 15 L	16.9 - 34	425 435 445	1 582	719	4 730	750	265
<b>460/85 - 34</b> (18.4 - 34)	152 A8 (149 B)	AF-01 TT	<b>W 15 L</b> W 14 L W 16 L	18.4 - 34	443 433 453	1 643	749	4 930	775	350

\* Further admissible rims on request

For intensive road transport at 80/65/50/40/30 km/h the pressure must be increased by 0.4 bar. Maximum inflation pressure should never be exceeded. All load values are valid for ground slopes up to and including 20% (11°). When operating on slopes greater than 20%, please, contact the producer.

AF-01



TL-01



	Tyre load capacity (kg) at tyre pressure (bar)							Speed (km/h)
	1.0	1.2	1.3	1.8	2.0	2.4	2.8	
	1 285	1 450	1 750	1 850	1 945	2 120		50
	1 425	1 600	1 950	2 050	2 140	<b>2 300</b>		40
	1 525	1 710	2 085	2 195	2 290	2 460		30
	1 875	2 085	2 505	2 715	2 925	3 170	3 370	10
	1 385	1 550	1 900	2 005	2 095	2 240		50
	1 510	1 700	2 060	2 170	2 270	<b>2 430</b>		40
	1 615	1 820	2 205	2 325	2 430	2 600		30
	1 980	2 210	2 655	2 875	3 000	3 360	3 585	10
	1 310	1 525	1 850	1 960	2 070	2 180		40
	1 635	1 905	2 315	2 450	2 585	<b>2 725</b>		30
	1 960	2 290	2 780	2 940	3 105	3 270		20
	2 290	2 670	3 240	3 430	3 625	3 815	4 060	10
	1 775	2 000	2 430	2 550	2 650	2 800		50
	1 940	2 180	2 650	2 785	2 900	<b>3 075</b>		40
	2 075	2 335	2 835	2 980	3 100	3 290		30
	2 550	2 840	3 410	3 695	3 975	4 300	4 555	10
	2 020	2 300	2 800	2 940	3 060	3 250		50
	2 225	2 500	3 075	3 225	3 355	<b>3 550</b>		40
	2 380	2 675	3 290	3 450	3 590	3 800		30
	2 925	3 255	3 925	4 265	4 615	4 980	5 270	10



**TD-01**

Durable traction pattern, also suitable for industrial use.



**TD-02**

Universal tread pattern with excellent traction for a wide range of applications.



**TD-05**

Unique tread pattern with 23 degree inclined blocks for better traction and self-cleaning properties. The reinforced shoulder prevents side-slipping and helps overall tyre strength.



**TD-13**

A classic design for tractors, well-tested and proven.



**TD-17**

Pattern featuring increased tread lug depth giving better traction and less slip in difficult conditions.



**TD-19**

Traction tread pattern with larger rib surface in the central part.

# **TD series – tractor drive diagonal tyres**

For tractors and other self-propelled  
agricultural machinery



## TD series

### Technical data and load capacities

Tyre size	Tread pattern	Type	Rim (permitted)	Tube	Section width (mm)	Overall diameter (mm)	Loaded static radius (mm)	Rolling circumference (mm)	
<b>8.3-20</b>	TD-13	TT	W7 (W6)	8.3-20	211	895	416	2 640	
<b>8.3-24</b>	TD-02	TT	W7 (W6)	8.3-24/9.5-24	211	995	470	2 935	
<b>9.5-24</b>	TD-02	TT	W8 (W7)	8.3-24/9.5-24	241	1 050	495	3 095	
<b>11.2-24</b>	TD-10	TL	W10 (W9)	(11.2-24)	284	1 105	520	3 300	
<b>11.2-24</b>	TD-02	TT	W10 (W9)	11.2-24	284	1 105	520	3 300	
<b>11.2-24</b>	TD-19	TT/TL	W10 (W9)	11.2-24	284	1 105	520	3 300	
<b>11.2-24</b>	TD-19	TL	W10 (W9)	(11.2-24)	284	1 105	520	3 300	
<b>12.4-24</b>	TD-02	TT	W11 (W9, W10)	12.4-24	315	1 160	539	3 473	
<b>12.4-24</b>	TD-19	TT/TL	W11 (W9, W10)	12.4-24	315	1 160	539	3 473	
<b>12.4-24</b>	TD-19	TL	W11 (W9, W10)	(12.4-24)	315	1 160	539	3 473	
<b>13.6-24</b>	TD-19	TT/TL	W11 (W12)	13.6-24	335	1 210	555	3 580	
<b>14.9-24</b>	TD-02	TT	W13 (W11, W12)	14.9-24	378	1 265	581	3 795	



	Ply rating PR	Service description LI/SS	Tyre load capacity (kg) at speed (km/h)				Tyre pressure (bar)
			10	20	30	40	
	6 PR	104 / 92 A8	530	465	410	370	0.8
			660	580	510	460	1.2
			785	695	610	550	1.6
			915	810	710	<b>630</b>	<b>2.0</b>
	6 PR	100 A6 (93 A8)	855	730	610	490	1.5
			940	800	670	540	1.8
			1 030	880	735	590	2.1
			1 120	960	800	<b>650</b>	<b>2.4</b>
	8 PR	112 A6 (104 A8)	1 220	1 045	870	700	1.8
			1 330	1 140	950	760	2.1
			1 465	1 255	1 045	840	2.5
			1 570	1 345	1 120	<b>900</b>	<b>2.8</b>
	6 PR	102 A8 (110 A6)	940	795	670	540	1.0
			1 330	1 140	950	760	1.5
			1 485	1 270	1 060	850	<b>1.8</b>
	8 PR	116 A6 (108 A8)	1 330	1 140	950	760	1.5
			1 485	1 270	1 060	850	1.8
			1 620	1 385	1 155	925	2.1
			1 750	1 500	1 250	<b>1 000</b>	<b>2.4</b>
	8 PR	116 A6 (108 A8)	1 330	1 140	950	760	1.5
			1 485	1 270	1 060	850	1.8
			1 620	1 385	1 155	925	2.1
			1 750	1 500	1 250	<b>1 000</b>	<b>2.4</b>
	10 PR	119 A8	1 970	1 450	1 400	1 310	2.8
			2 040	1 510	1 460	<b>1 360</b>	<b>3.0</b>
	8 PR	120 A6 (112 A8)	1 580	1 355	1 130	905	1.5
			1 700	1 460	1 215	970	1.7
			1 835	1 570	1 310	1 050	2.0
			1 960	1 680	1 400	<b>1 120</b>	<b>2.3</b>
	8 PR	120 A6 (112 A8)	1 580	1 355	1 130	905	1.5
			1 700	1 460	1 215	970	1.7
			1 835	1 570	1 310	1 050	2.0
			1 960	1 680	1 400	<b>1 120</b>	<b>2.3</b>
	12 PR	128 A8	2 420	1 790	1 720	1 610	2.9
			2 520	1 860	1 800	1 680	3.1
			2 610	1 930	1 860	1 740	3.3
			2 700	2 000	1 930	<b>1 800</b>	<b>3.5</b>
	8 PR	123 A6 (116 A8)	1 975	1 695	1 410	1 130	1.4
			2 085	1 790	1 490	1 190	1.7
			2 170	1 860	1 550	<b>1 250</b>	<b>2.0</b>
	8 PR	128 A6 (121 A8)	2 345	2 010	1 675	1 340	1.6
			2 520	2 160	1 800	<b>1 450</b>	<b>1.8</b>

## TD series (continued)

### Technical data and load capacities

Tyre size	Tread pattern	Type	Rim (permitted)	Tube	Section width (mm)	Overall diameter (mm)	Loaded static radius (mm)	Rolling circumference (mm)	
<b>14.9-24</b>	TD-19	TT/TL	W13 (W11, W12)	14.9-24	378	1 265	581	3 795	
<b>16.9-24</b>	TD-02	TT	W15L (W14L)	16.9-24	429	1 335	620	3 940	
<b>16.9-24</b>	TD-13	TT/TL	W15L (W14L)	16.9-24	429	1 335	620	3 940	
<b>18.4-26</b>	TD-19	TL	W16L(W15L)	(18.4-26)	467	1 450	663	4 285	
<b>23.1-26</b>	TD-01	TL	DW20	(23.1-26)	587	1 605	760	4 720	
<b>11.2-28</b>	TD-02	TT	W10 (W9)	11.2-28	284	1 205	565	3 555	
<b>11.2-28</b>	TD-02	TT	W10 (W9)	11.2-28	284	1 205	565	3 555	
<b>12.4-28</b>	TD-02	TT	W11 (W10)	12.4-28	315	1 260	598	3 750	
<b>12.4-28</b>	TD-19	TT	W11 (W10)	12.4-28	315	1 260	598	3 750	
<b>12.4-28</b>	TD-19	TT	W11 (W10)	12.4-28	315	1 260	598	3 750	
<b>13.6-28</b>	TD-19	TT	W12 (W11)	13.6-28	345	1 310	612	3 853	





	Ply rating PR	Service description LI/SS	Tyre load capacity (kg) at speed (km/h)				Tyre pressure (bar)
			10	20	30	40	
8 PR	128 A6 (121 A8)	1 990	1 705	1 420	1 135	1.2	
		2 170	1 860	1 550	1 250	1.4	
		2 345	2 010	1 675	1 340	1.6	
		2 520	2 160	1 800	<b>1 450</b>	<b>1.8</b>	
8 PR	133 A6 (125 A8)	2 240	1 920	1 600	1 280	1.1	
		2 450	2 100	1 750	1 400	1.3	
		2 665	2 285	1 905	1 525	1.5	
		2 885	2 470	2 060	<b>1 650</b>	<b>1.7</b>	
8 PR	133 A6 (125 A8)	2 240	1 920	1 600	1 280	1.1	
		2 450	2 100	1 750	1 400	1.3	
		2 665	2 285	1 905	1 525	1.5	
		2 885	2 470	2 060	<b>1 650</b>	<b>1.7</b>	
12 PR	156 A8	4 785	3 470	3 380	3 190	1.9	
		5 430	3 940	3 830	3 620	2.2	
		6 000	4 360	4 160	<b>4 000</b>	<b>2.5</b>	
14 PR	156 A8	4 350	3 565	3 100	2 900	1.1	
		4 875	4 000	3 480	3 250	1.4	
		5 475	4 490	3 905	3 650	1.7	
		6 000	4 920	4 280	<b>4 000</b>	<b>2.0</b>	
6 PR	112 A6 (104 A8)	1 260	1 080	900	720	1.3	
		1 415	1 210	1 010	810	1.5	
		1 570	1 345	1 120	<b>900</b>	<b>1.8</b>	
8 PR	118 A6 (110 A8)	1 710	1 465	1 220	975	2.1	
		1 850	1 585	1 320	<b>1 060</b>	<b>2.4</b>	
8 PR	123 A6 (116 A8)	1 445	1 235	1 030	825	1.1	
		1 620	1 385	1 155	925	1.4	
		1 800	1 540	1 285	1 030	1.7	
		2 005	1 715	1 430	1 145	2.0	
		2 170	1 860	1 550	<b>1 250</b>	<b>2.3</b>	
6 PR	117 A6 (109 A8)	1 445	1 235	1 030	825	1.1	
		1 620	1 385	1 155	925	1.4	
		1 800	1 540	1 285	<b>1 030</b>	<b>1.7</b>	
10 PR	128 A6 (121 A8)	2 005	1 715	1 430	1 145	2.0	
		2 170	1 860	1 550	1 250	2.3	
		2 335	2 000	1 650	1 335	2.5	
		2 535	2 175	1 790	<b>1 450</b>	<b>2.8</b>	
6 PR	121 A6 (113 A8)	1 570	1 345	1 120	895	1.0	
		1 720	1 475	1 230	985	1.2	
		1 875	1 610	1 340	1 070	1.4	
		2 030	1 740	1 450	<b>1 150</b>	<b>1.6</b>	

## TD series (continued)

### Technical data and load capacities

Tyre size	Tread pattern	Type	Rim (permitted)	Tube	Section width (mm)	Overall diameter (mm)	Loaded static radius (mm)	Rolling circumference (mm)	
<b>14.9-28</b>	TD-19	TT	W13 (W12)	14.9-28	378	1 365	627	4 113	
<b>16.9-28</b>	TD-02	TT	W15L (W14L)	16.9-28	429	1 435	670	4 235	
<b>16.9-28</b>	TD-13	TT	W15L (W14L)	16.9-28	429	1 435	670	4 235	
<b>16.9-28</b>	TD-13	TT	W15L (W14L)	16.9-28	429	1 435	670	4 235	
<b>16.9-30</b>	TD-13	TT/TL	W15L (W14L)	16.9-30	429	1 485	685	4 390	
<b>16.9-30</b>	TD-13	TT	W15L (W14L)	16.9-30	429	1 485	685	4 390	
<b>16.9-30</b>	TD-13	TT	W15L (W14L)	16.9-30	429	1 485	685	4 390	
<b>16.9-30</b>	TD-17	TT	W15L (W14L)	16.9-30	429	1 485	685	4 390	
<b>16.9-30</b>	TD-17	TT	W15L (W14L)	16.9-30	429	1 485	685	4 390	
<b>18.4-30</b>	TD-13	TT/TL	W16L (W15L)	16.9-30	467	1 550	714	4 540	
<b>18.4-30</b>	TD-13	TT	W16L (W15L)	16.9-30	467	1 550	714	4 540	
<b>18.4-30</b>	TD-13	TT	W16L (W15L)	16.9-30	467	1 550	714	4 540	
<b>9.5-32</b>	TD-13	TT	W8 (W7)	9.5-32	241	1 250	597	3 695	
<b>12.4-32</b>	TD-13	TT	W11 (W9, W10)	12.4-32	315	1 360	633	3 975	
<b>16.9-34</b>	TD-02	TT	W15L (W14L)	16.9-34	429	1 585	724	4 680	
<b>16.9-34</b>	TD-02	TT	W15L (W14L)	16.9-34	429	1 585	724	4 680	



	Ply rating PR	Service description LI/SS	Tyre load capacity (kg) at speed (km/h)				Tyre pressure (bar)
			10	20	30	40	
	<b>8 PR</b>	130 A6 (122 A8)	1 905	1 630	1 360	1 090	1.0
2 115			1 810	1 510	1 210	1.2	
2 395			2 050	1 710	1 370	1.5	
2 660			2 280	1 900	<b>1 500</b>	<b>1.8</b>	
	<b>10 PR</b>	139 A6 (131 A8)	3 305	2 830	2 360	1 890	1.9
3 400			2 915	2 430	<b>1 950</b>	<b>2.0</b>	
	<b>8 PR</b>	135 A6 (127 A8)	2 355	2 015	1 680	1 345	1.1
2 730			2 340	1 950	1 560	1.4	
3 055			2 615	2 180	<b>1 750</b>	<b>1.7</b>	
	<b>10 PR</b>	139 A6 (131 A8)	3 305	2 830	2 360	1 890	1.9
3 400			2 915	2 430	<b>1 950</b>	<b>2.0</b>	
	<b>8 PR</b>	137 A6 (129 A8)	2 410	2 065	1 720	1 375	1.1
2 885			2 470	2 060	1 650	1.4	
3 220			2 760	2 300	<b>1 850</b>	<b>1.7</b>	
	<b>10 PR</b>	140 A6 (132 A8)	3 500	3 000	2 500	<b>2 000</b>	<b>2.0</b>
	<b>12 PR</b>	143 A6 (135 A8)	3 815	3 270	2 725	<b>2 180</b>	<b>2.3</b>
	<b>8 PR</b>	137 A6 (129 A8)	2 410	2 065	1 720	1 375	1.1
2 885			2 470	2 060	1 650	1.4	
3 220			2 760	2 300	<b>1 850</b>	<b>1.7</b>	
	<b>10 PR</b>	140 A6 (132 A8)	3 500	3 000	2 500	<b>2 000</b>	<b>2.0</b>
	<b>8 PR</b>	139 A6 (131 A8)	2 645	2 270	1 890	1 515	0.9
3 110			2 665	2 220	1 775	1.2	
3 400			2 915	2 430	<b>1 950</b>	<b>1.4</b>	
	<b>12 PR</b>	149 A6 (141 A8)	4 355	3 730	3 110	2 490	2.1
4 550			3 900	3 250	<b>2 575</b>	<b>2.3</b>	
	<b>14 PR</b>	152 A6 (144 A8)	4 745	4 070	3 390	2 710	2.5
4 970			4 260	3 550	<b>2 800</b>	<b>2.7</b>	
	<b>6 PR</b>	110 A6 (102 A8)	1 190	1 020	850	680	1.5
1 290			1 100	920	740	1.7	
1 390			1 190	990	790	1.9	
1 480			1 270	1 060	<b>850</b>	<b>2.1</b>	
	<b>6 PR</b>	119 A6 (111 A8)	1 490	1 275	1 065	850	1.1
1 625			1 390	1 160	930	1.3	
1 755			1 505	1 255	1 005	1.5	
1 905			1 630	1 360	<b>1 090</b>	<b>1.7</b>	
	<b>8 PR</b>	139 A6 (131 A8)	2 620	2 245	1 870	1 495	1.1
3 010			2 580	2 150	1 720	1.4	
3 400			2 915	2 430	<b>1 950</b>	<b>1.7</b>	
	<b>10 PR</b>	142 A6 (134 A8)	3 710	3 180	2 650	<b>2 120</b>	<b>2.0</b>

**TD series (continued)**

## Technical data and load capacities

Tyre size	Tread pattern	Type	Rim (permitted)	Tube	Section width (mm)	Overall diameter (mm)	Loaded static radius (mm)	Rolling circumference (mm)	
<b>16.9-34</b>	TD-17	TT	W15L (W14L)	16.9-34	429	1 585	724	4 680	
<b>18.4-34</b>	TD-02	TT	W16L (W15L)	16.9-34 18.4-34	467	1 650	770	4 865	
<b>18.4-34</b>	TD-19	TT/TL	W16L (W15L)	16.9-34 18.4-34	467	1 650	770	4 865	
<b>18.4-34</b>	TD-19	TT	W16L (W15L)	16.9-34 18.4-34	467	1 650	770	4 865	
<b>12.4-36</b>	TD-13	TT	W11 (W10)	12.4-36	315	1 465	685	4 330	
<b>12.4-36</b>	TD-13	TT	W11 (W10)	12.4-36	315	1 465	685	4 330	
<b>13.6-36</b>	TD-13	TT	W12 (W11)	13.6-36	345	1 515	698	4 447	
<b>12.4-38</b>	TD-17	TT	W11 (W10)	12.4-38	320	1 515	719	4 514	
<b>13.6-38</b>	TD-02	TT	W12 (W11)	13.6-38	345	1 565	740	4 615	
<b>13.6-38</b>	TD-13	TT	W12 (W11)	13.6-38	345	1 565	740	4 670	
<b>13.6-38</b>	TD-13	TT	W12 (W11)	13.6-38	345	1 565	740	4 670	



	Ply rating PR	Service description LI/SS	Tyre load capacity (kg) at speed (km/h)				Tyre pressure (bar)
			10	20	30	40	
	<b>8 PR</b>	139 A6 (131 A8)	2 620	2 245	1 870	1 495	1.1
3 010			2 580	2 150	1 720	1.4	
3 400			2 915	2 430	<b>1 950</b>	<b>1.7</b>	
	<b>12 PR</b>	151 A6 (144 A8)	3 050	2 615	2 180	1 745	1.0
3 380			2 900	2 415	1 930	1.2	
3 710			3 180	2 650	2 120	1.4	
3 955			3 390	2 825	2 260	1.6	
4 200			3 600	3 000	2 430	1.8	
4 580			3 925	3 270	2 620	2.1	
4 830			4 140	3 450	<b>2 800</b>	<b>2.3</b>	
	<b>8 PR</b>	142 A6 (134 A8)	3 050	2 615	2 180	1 745	1.0
3 380			2 900	2 415	1 930	1.2	
3 710			3 180	2 650	<b>2 120</b>	<b>1.4</b>	
	<b>12 PR</b>	151 A6 (144 A8)	4 580	3 925	3 270	2 620	2.1
4 830			4 140	3 450	<b>2 800</b>	<b>2.3</b>	
	<b>6 PR</b>	121 A6 (113 A8)	1 610	1 380	1 150	920	1.1
1 750			1 500	1 250	1 000	1.3	
1 890			1 620	1 350	1 080	1.5	
2 030			1 740	1 450	<b>1 150</b>	<b>1.7</b>	
	<b>12 PR</b>	135 A6 (127 A8)	2 610	2 240	1 865	1 490	2.7
2 750			2 360	1 965	1 570	2.9	
2 900			2 485	2 070	1 655	3.1	
3 050			2 615	2 180	<b>1 750</b>	<b>3.3</b>	
	<b>6 PR</b>	125 A6 (118 A8)	1 625	1 390	1 160	930	0.9
1 895			1 625	1 355	1 085	1.2	
2 080			1 780	1 485	1 190	1.4	
2 310			1 980	1 650	<b>1 320</b>	<b>1.6</b>	
	<b>8 PR</b>	127 A6 (120 A8)	2 070	1 775	1 480	1 185	1.7
2 200			1 885	1 570	1 255	1.9	
2 325			1 990	1 660	1 330	2.1	
2 450			2 100	1 750	<b>1 400</b>	<b>2.3</b>	
	<b>6 PR</b>	126 A6 (119 A8)	1 695	1 450	1 210	970	0.9
2 015			1 730	1 440	1 150	1.2	
2 200			1 885	1 570	1 255	1.4	
2 380			2 040	1 700	<b>1 360</b>	<b>1.6</b>	
	<b>6 PR</b>	126 A6 (119 A8)	1 695	1 450	1 210	970	0.9
2 015			1 730	1 440	1 150	1.2	
2 200			1 885	1 570	1 255	1.4	
2 380			2 040	1 700	<b>1 360</b>	<b>1.6</b>	
	<b>14 PR</b>	139 A6 (131 A8)	2 920	2 500	2 085	1 670	2.9
3 075			2 635	2 195	1 755	3.1	
3 235			2 770	2 310	1 850	3.3	
3 400			2 915	2 430	<b>1 950</b>	<b>3.5</b>	

## TD series (continued)

### Technical data and load capacities

Tyre size	Tread pattern	Type	Rim (permitted)	Tube	Section width (mm)	Overall diameter (mm)	Loaded static radius (mm)	Rolling circumference (mm)	
<b>14.9 - 38</b>	TD-05	TT	W13 (W12)	14.9 - 38	380	1 640	760	4 838	
<b>15.5 - 38</b>	TD-05	TT/TL	W14L	15.5 - 38	394	1 580	745	4 661	
<b>16.9 - 38</b>	TD-19	TT/TL	W15L (W14L)	16.9 - 38	429	1 685	795	5 091	
<b>16.9 - 38</b>	TD-13	TT	W15L (W14L)	16.9 - 38	429	1 685	795	5 091	
<b>18.4 - 38</b>	TD-19	TT/TL	W16L (W15L)	18.4 - 38	467	1 750	814	5 216	

The inflation pressure must be increased for front-end loader tractor application +0.4 bar.

For Non-standard version, please contact a producer.

These tyres are for normal agricultural use and not for continuous highway service.



Ply rating PR	Service description LI/SS	Tyre load capacity (kg) at speed (km/h)				Tyre pressure (bar)
		10	20	30	40	
6 PR	129 A6 (122 A8)	2 190	1 880	1 565	1 250	1.0
		2 380	2 040	1 700	1 360	1.2
		2 590	2 220	1 850	<b>1 480</b>	<b>1.4</b>
8 PR	133 A6 (125 A8)	2 470	2 120	1 765	1 400	1.4
		2 655	2 275	1 895	1 520	1.6
		2 885	2 475	2 060	<b>1 650</b>	<b>1.8</b>
8 PR	141 A6 (133 A8)	2 620	2 245	1 870	1 495	1.0
		3 050	2 615	2 180	1 745	1.3
		3 325	2 850	2 375	1 900	1.5
		3 605	3 090	2 575	<b>2 060</b>	<b>1.7</b>
8 PR	141 A6 (133 A8)	2 620	2 245	1 870	1 495	1.0
		3 050	2 615	2 180	1 745	1.3
		3 325	2 850	2 375	1 900	1.5
		3 605	3 090	2 575	<b>2 060</b>	<b>1.7</b>
8 PR	143 A6 (135 A8)	3 025	2 590	2 160	1 730	0.9
		3 485	2 990	2 490	1 990	1.2
		3 815	3 270	2 725	<b>2 180</b>	<b>1.4</b>



**IM-01**

Tested and proven tread pattern for transportation, also suitable for powered wheels.



**IM-02**

Tread pattern with excellent traction for a wide range of applications.



**IM-03**

A classic implement design for universal use.



**IM-04**

Modern universal tread pattern suitable for a wide range of agricultural uses.



**IM-06**

Ribbed pattern for all sorts of applications.



**IM-07**

Pattern with rolling rib profile without any lateral tread elements. Suitable for meadowland use or soil cultivation.



**IM-08**

Ribbed pattern without any lateral tread elements, suitable for meadowland use and transport service.



**IM-09**

Traction pattern with strong side lugs. Low inflation pressure for reduced soil compaction.



# IM series – Implement Diagonal

## Great transportation properties

---



**IM-10**

Ribbed pattern without any lateral tread elements. Suitable for soil cultivation and for light transport applications.



**IM-11**

Good track holding for trailed wheels due to rolling rib profile and strong side lugs.



**AC 30**

Robust tread pattern for construction vehicles.



**B 3**

Specially designed for garden tractors, large mowers and municipal tractors.



**G1**

Perfect tread pattern for small machines and tools as lawn mowers.



**B 19**

Ribbed tread pattern with rounded shoulder. Good stability and self-cleaning properties. Ideal for small horticultural and hay making machinery.



**B 63**

Special tread pattern with good stability, lawn protection and comfort.

## IM series

### Technical data and load capacities

Tyre size	Tread pattern	Type	Rim (permitted)	Tube	Section width (mm)	Overall diameter (mm)	Loaded static radius (mm)	Rolling circumference (mm)	
<b>13×5.00-6</b>	G 1	TT/TL	3.50×6	4.00-6	124	322	148	963	
<b>13×5.00-6</b>	B 19	TT/TL	3.50×6	4.00-6	124	322	148	963	
<b>13×5.00-6</b>	B 19	TT/TL	3.50×6	4.00-6	124	322	148	963	
<b>15×6.00-6</b>	B 19	TT/TL	4.50×6	15×6.00-6	150	362	165	1 082	
<b>16×6.50-8</b>	B 19	TT/TL	5.375×8	16×6.50/7.50-8	165	408	189	1 220	
<b>16×6.50-8</b>	B 19	TT/TL	5.375×8	16×6.50/7.50-8	165	408	189	1 220	
<b>16×6.50-8</b>	B 19	TT/TL	5.375×8	16×6.50/7.50-8	165	408	189	1 220	
<b>18×8.50-8</b>	G 1	TT/TL	7.00×8	18×8.50/9.50-8	214	462	212	1 381	
<b>18.5×8.50-8</b> (215/65-8)	B 63	TL	7.00×8	18×8.50/9.50-8	215	460	211	1 375	
<b>18.5×8.50-8</b> (215/65-8)	B 63	TL	7.00×8	18×8.50/9.50-8	215	460	211	1 375	
<b>4.00-10</b>	IM-06	TT	3.00D×10	4.00-10	114	465	230	1 365	
<b>7.00-12</b>	IM-11	TL	4.25×12 5 JA×12(TT)		187 195	687	316	2 070	
<b>10.0/80-12</b>	IM-04	TT/TL	9.00×12 (7.00×12)	10.0/80-12	264	710	316	2 085	
<b>10.0/80-12</b>	IM-04	TL	9.00×12 (7.00×12)	10.0/80-12	264	710	316	2 085	
<b>10.0/80-12</b>	IM-08	TL	9.00×12 (7.00×12)	10.0/80-12	264	735	335	2 160	



	Ply rating PR	Service description LI/SS	Tyre load capacity (kg) at speed (km/h)					Tyre pressure (bar)
			10	20	30	40	50	
	<b>4 PR</b>	49 A4	211	185				2.25
	<b>4 PR</b>	49 A4	211	185				2.25
	<b>8 PR</b>	66 A4	342	300				4.25
	<b>6 PR</b>	72 A4	405	355				3.00
	<b>6 PR</b>	70 A4	382	335				3.00
	<b>10 PR</b>	77 A4	470	412				3.75
	<b>12 PR</b>	80 A4	513	450				4.00
	<b>6 PR</b>	78 A4	485	425				2.75
	<b>6 PR</b>	78 A6	548	485	<b>425</b>			3.50
	<b>12 PR</b>	90 A6	774	684	<b>600</b>			6.30
	<b>4 PR</b>	62 A6	200	175	155	140		1.00
			240	210	185	165		1.50
			285	250	220	200		2.00
			325	285	250	225		2.50
			340	300	<b>265</b>	240		<b>2.75</b>
	<b>6 PR</b>	95 A6	525	465	405	365		1.00
			580	510	445	400		1.20
			685	605	525	475		1.60
			730	650	565	505		1.80
			780	690	600	540		2.00
			885	780	<b>690</b>	610		<b>2.50</b>
	<b>8 PR</b>	112 A8	1 175	1 060	940	840	755	1.75
			1 225	1 105	980	875	790	2.00
			1 330	1 200	1 065	950	855	2.30
			1 360	1 220	1 085	970	875	2.50
			1 450	1 305	1 160	1 035	930	2.75
			1 570	1 410	1 255	<b>1 120</b>	1 010	<b>3.10</b>
	<b>10 PR</b>	117 A8	1 650	1 485	1 320	1 180	1 060	3.40
			1 745	1 570	1 395	1 245	1 120	3.70
			1 800	1 620	1 440	<b>1 285</b>	1 155	<b>3.90</b>
	<b>8 PR</b>	112 A8	1 175	1 060	940	840	755	1.75
			1 225	1 105	980	875	790	2.00
			1 330	1 200	1 065	950	855	2.30
			1 360	1 220	1 085	970	875	2.50
			1 450	1 305	1 160	1 035	930	2.75
			1 570	1 410	1 255	<b>1 120</b>	1 010	<b>3.10</b>

## IM series (continued)

### Technical data and load capacities

Tyre size	Tread pattern	Type	Rim (permitted)	Tube	Section width (mm)	Overall diameter (mm)	Loaded static radius (mm)	Rolling circumference (mm)
200/60-14.5	IM-10	TT/TL	6.75 × 14.5		200	620	285	1 823
28 × 9.00-15	AC 30	TT	7.00 I × 15 6 1/2 K × 15	43GS16	234 229	710	322	2 160
240/70-15	B 3	TL	7.00 I × 15 6 1/2 K × 15		232 227	721	322	2 135
10.0/75-15.3	IM-04	TT/TL	9.00 × 15.3	10-15 HS 10/75-15	264	760	351	2 235
10.0/75-15.3	IM-04	TT/TL	9.00 × 15.3	10-15 HS 10/75-15	264	760	351	2 235
10.0/75-15.3	IM-04	TT/TL	9.00 × 15.3	10-15 HS 10/75-15	264	760	351	2 235
10.0/75-15.3	IM-04	TL	9.00 × 15.3	10-15 HS 10/75-15	264	760	351	2 235
11.5/80-15.3	IM-04	TT/TL	9.00 × 15.3	11.5/80-15	290	845	386	2 485
11.5/80-15.3	IM-04	TT/TL	9.00 × 15.3	11.5/80-15	290	845	386	2 485
11.5/80-15.3	IM-04	TT/TL	9.00 × 15.3	11.5/80-15	290	845	386	2 485
11.5/80-15.3	IM-04	TT/TL	9.00 × 15.3	11.5/80-15	290	845	386	2 485
12.5/80-15.3	IM-04	TL	9.00 × 15.3	-	307	889	436	2 615



	Ply rating PR	Service description LI/SS	Tyre load capacity (kg) at speed (km/h)					Tyre pressure (bar)		
			10	20	30	40	50			
	<b>10 PR</b>	102 A8	600	540	480	430	390	1.50		
			720	650	575	515	465	2.00		
			805	725	645	575	520	2.50		
			880	795	705	630	565	3.00		
			960	865	765	685	615	3.50		
			1 035	930	830	740	665	4.00		
			1 115	1 000	890	795	715	4.50		
			1 190	1 070	950	<b>850</b>	765	<b>5.00</b>		
	<b>6 PR</b>	102 A5	455	435	425			0.70		
			510	495	480			0.90		
			545	525	510			1.00		
			695	670	650			1.50		
			810	780	760			2.00		
			905	875	<b>850</b>			<b>2.50</b>		
	<b>8 PR</b>	115 A8	1 210	640	580	510		1.00		
			1 660	895	790	710	640	1.60		
			1 810	970	860	770	690	2.00		
			2 500	1 350	1 190	1 070	960	3.00		
			2 770	1 485	1 320	1 180	1 060	3.50		
			2 860	1 530	1 360	<b>1 215</b>	1 090	<b>4.00</b>		
			<b>10 PR</b>	122 A8	1 665	1 500	1 335	1 190	1 070	2.50
					1 850	1 665	1 480	1 320	1 190	3.00
	1 975	1 775			1 580	1 410	1 270	3.50		
	2 100	1 890			1 680	<b>1 500</b>	1 350	<b>4.00</b>		
	<b>12 PR</b>	125 A8	2 240	2 015	1 790	1 600	1 440	4.50		
			2 310	2 080	1 850	<b>1 650</b>	1 485	<b>4.75</b>		
	<b>14 PR <sup>(1)</sup></b>	130 A8	2 430	2 185	1 945	1 735	1 560	5.00		
			2 660	2 395	2 130	<b>1 900</b>	1 710	<b>5.50</b>		
	<b>18 PR <sup>(1)</sup></b>	143 A8	3 025	2 720	2 420	2 160	1 945	6.00		
			3 380	3 045	2 705	2 415	2 175	6.50		
			3 815	3 435	3 050	<b>2 725</b>	2 455	<b>7.10</b>		
	<b>10 PR</b>	130 A8	2 065	1 860	1 650	1 475	1 330	2.50		
			2 430	2 185	1 945	1 735	1 565	3.00		
			2 660	2 395	2 130	<b>1 900</b>	1 710	<b>3.50</b>		
	<b>12 PR</b>	134 A8	2 815	2 535	2 250	2 010	1 810	3.75		
			2 970	2 670	2 375	<b>2 120</b>	1 910	<b>4.00</b>		
	<b>14 PR</b>	139 A8	3 260	2 935	2 610	2 330	2 095	4.50		
			3 400	3 060	2 720	<b>2 430</b>	2 185	<b>4.75</b>		
	<b>16 PR <sup>(2)</sup></b>	141 A8	3 470	3 125	2 780	2 480	2 230	5.00		
			3 605	3 245	2 885	<b>2 575</b>	2 320	<b>5.40</b>		
	<b>14 PR</b>	141 A8	2 920	2 625	2 335	2 085	1 875	3.25		
			3 110	2 795	2 485	2 220	2 000	3.50		
			3 305	2 975	2 645	2 360	2 125	3.70		
			3 485	3 135	2 790	2 490	2 240	4.00		
			3 605	3 245	2 885	<b>2 575</b>	2 320	<b>4.30</b>		

## IM series (continued)

### Technical data and load capacities

Tyre size	Tread pattern	Type	Rim (permitted)	Tube	Section width (mm)	Overall diameter (mm)	Loaded static radius (mm)	Rolling circumference (mm)	
<b>400/60 - 15.5</b>	IM-07	TL	13.00×15.5	-	405	875	380	2 575	
<b>400/60 - 15.5</b>	IM-07	TL	13.00×15.5	-	405	875	380	2 575	
<b>400/60 - 15.5</b>	IM-07	TL	13.00×15.5	-	405	875	380	2 575	
<b>10.50 - 16</b>	IM-01	TT	7.00I-16 (7.0-40I.5)	10.50-16	274	945	432	2 780	
<b>15.0/55 - 17</b>	IM-04	TL	13.00×17 (13×17)	15.0/55-17	391	850	410	2 499	
<b>15.0/55 - 17</b>	IM-04	TL	13.00×17	15.0/55-17	391	850	410	2 499	
<b>19.0/45 - 17</b>	IM-04	TL	16.00×17	-	491	866	390	2 546	
<b>19.0/45 - 17</b>	IM-04	TL	16.00×17	-	491	866	390	2 546	
<b>500/50 - 17</b>	IM-07	TL	16.00×17	-	500	940	420	2 763	
<b>500/50 - 17</b>	IM-07	TL	16.00×17	-	500	940	420	2 763	
<b>12.5/80 - 18</b>	IM-03	TT	11×18 (9×18)	12-18 HS 12.5-18	308	965	444	2 840	



	Ply rating PR	Service description LI/SS	Tyre load capacity (kg) at speed (km/h)					Tyre pressure (bar)
			10	20	30	40	50	
	<b>14 PR</b>	140 A8	2 015	1 815	1 615	1 440	1 295	1.25
			2 185	1 965	1 745	1 560	1 405	1.50
			2 520	2 270	2 015	1 800	1 620	2.00
			2 800	2 520	2 240	2 000	1 800	2.50
			3 150	2 835	2 520	2 250	2 025	3.00
			3 500	3 150	2 800	<b>2 500</b>	2 250	<b>3.50</b>
	-	145 A8	4 060	3 650	3 250	<b>2 900</b>	2 610	<b>3.60</b>
	-	152 A8	4 410	3 970	3 530	3 150	2 835	4.00
			4 690	4 220	3 750	3 350	3 015	5.00
			4 970	4 475	3 975	<b>3 550</b>	3 195	<b>6.00</b>
	<b>14 PR</b>	144 A8	2 870	2 585	2 295	2 050	1 845	3.25
			2 970	2 670	2 375	2 120	1 910	3.50
			3 220	2 900	2 575	2 300	2 070	4.00
			3 470	3 125	2 780	2 480	2 230	4.50
			3 710	3 340	2 970	2 650	2 385	5.00
			3 920	3 530	3 135	<b>2 800</b>	2 520	<b>5.25</b>
	<b>10 PR</b>	131 A8	2 325	2 090	1 860	1 660	1 495	2.00
			2 595	2 335	2 080	1 855	1 670	2.40
			2 730	2 455	2 185	<b>1 950</b>	1 755	<b>2.60</b>
	<b>14 PR</b>	137 A8	2 830	2 545	2 260	2 020	1 820	2.80
			2 970	2 670	2 375	2 120	1 910	3.10
			3 050	2 745	2 440	2 180	1 960	3.30
			3 135	2 820	2 510	2 240	2 015	3.50
			3 220	2 900	2 575	<b>2 300</b>	2 070	<b>3.70</b>
	<b>14 PR</b>	144 A8	2 605	2 345	2 085	1 860	1 675	2.00
			2 980	2 685	2 385	2 130	1 915	2.50
			3 305	2 975	2 645	2 360	2 125	3.00
			3 625	3 265	2 900	2 590	2 330	3.50
			3 920	3 530	3 135	<b>2 800</b>	2 520	<b>4.00</b>
	<b>18 PR</b>	157 A8	5 110	4 600	4 090	3 650	3 285	4.75
			5 320	4 790	4 255	3 800	3 420	5.00
			5 545	4 990	4 435	3 960	3 565	5.25
			5 775	5 195	4 620	<b>4 125</b>	3 715	<b>5.50</b>
	<b>14 PR</b>	149 A8	3 330	3 000	2 665	2 380	2 140	2.00
			3 815	3 435	3 050	2 725	2 455	2.50
			4 200	3 780	3 360	3 000	2 700	3.00
			4 550	4 095	3 640	<b>3 250</b>	2 925	<b>3.50</b>
	<b>18 PR</b>	155 A8	4 985	4 485	3 985	3 560	3 200	4.00
			5 425	4 880	4 340	<b>3 875</b>	3 490	<b>4.40</b>
	<b>14 PR</b>	145 A8	2 715	2 445	2 175	1 940	1 745	2.25
			2 885	2 595	2 305	2 060	1 855	2.50
			3 305	2 975	2 645	2 360	2 125	3.00
			3 565	3 205	2 850	2 545	2 290	3.50
			3 870	3 485	3 095	2 765	2 490	4.00
			4 060	3 655	3 250	<b>2 900</b>	2 610	<b>4.25</b>

## IM series (continued)

### Technical data and load capacities

Tyre size	Tread pattern	Type	Rim (permitted)	Tube	Section width (mm)	Overall diameter (mm)	Loaded static radius (mm)	Rolling circumference (mm)	
<b>12.5/80-18</b>	IM-03	TT	11×18 (9×18)	12-18 HS 12.5-18	308	965	444	2 840	
<b>12.5/80-18</b>	IM-04	TT	11×18 (9×18)	12-18 HS 12.5-18	308	965	444	2 840	
<b>12.5/80-18</b>	IM-04	TT	11×18 (9×18)	12-18 HS 12.5-18	308	965	444	2 840	
<b>13.0/65-18</b>	IM-04	TT	11×18	13.0/65-18	336	890	412	2 615	
<b>360/95-18</b> (13.00-18)	IM-02	TT	9A×18	12.00-18	370	1 128	514	3 315	
<b>14.5/80-18</b>	IM-03	TT	13×18	14.5/80-18	372	1 045	475	3 075	
<b>500/60-22.5</b>	IM-09	TL	16.00×22.5	-	503	1 172	511	3 446	
<b>550/60-22.5</b>	IM-09	TL	16.00×22.5	-	537	1 232	534	3 622	

<sup>0)</sup> Reinforced version also available (REINFORCED)

For Non-standard version, please contact a producer.

These tyres are for normal agricultural use and not for continuous highway service.





	Ply rating PR	Service description LI/SS	Tyre load capacity (kg) at speed (km/h)					Tyre pressure (bar)
			10	20	30	40	50	
	<b>16 PR</b>	147 A8	4 145	3 730	3 315	2 960	2 665	4.50
			4 305	3 875	3 445	<b>3 075</b>	2 770	<b>5.00</b>
	<b>14 PR</b>	145 A8	2 715	2 445	2 175	1 940	1 745	2.25
			2 885	2 595	2 305	2 060	1 855	2.50
			3 305	2 975	2 645	2 360	2 125	3.00
			3 565	3 205	2 850	2 545	2 290	3.50
			3 870	3 485	3 095	2 765	2 490	4.00
			4 060	3 655	3 250	<b>2 900</b>	2 610	<b>4.25</b>
	<b>16 PR</b>	147 A8	4 145	3 730	3 315	2 960	2 665	4.50
			4 305	3 875	3 445	<b>3 075</b>	2 770	<b>5.00</b>
	<b>16 PR</b>	143 A8	2 270	2 040	1 815	1 620	1 460	2.00
			2 575	2 320	2 060	1 840	1 655	2.50
			2 885	2 595	2 305	2 060	1 855	3.00
			3 220	2 900	2 575	2 300	2 070	3.50
			3 400	3 060	2 720	2 430	2 185	4.00
			3 605	3 245	2 885	2 575	2 320	4.50
	3 815	3 435	3 050	<b>2 725</b>	2 455	<b>5.00</b>		
	<b>12 PR</b>	150 A8	3 555	3 200	2 845	2 540	2 285	2.50
			4 200	3 780	3 360	3 000	2 700	3.00
			4 690	4 220	3 750	<b>3 350</b>	3 015	<b>3.50</b>
	<b>12 PR</b>	155 A8	2 850	2 565	2 280	2 035	1 830	1.50
			3 310	2 980	2 650	2 365	2 130	2.00
			3 765	3 390	3 015	2 690	2 420	2.50
			4 215	3 795	3 370	3 010	2 710	3.00
			4 660	4 195	3 730	3 330	2 995	3.50
			5 125	4 610	4 100	3 660	3 295	4.00
	5 425	4 885	4 340	<b>3 875</b>	3 490	<b>4.25</b>		
	<b>16 PR</b>	159 A8	3 955	3 560	3 165	2 825	2 545	1.50
			4 390	3 950	3 510	3 135	2 820	1.80
			4 825	4 340	3 860	3 445	3 100	2.10
			5 250	4 725	4 200	3 750	3 375	2.40
			5 690	5 120	4 555	4 065	3 660	2.70
			6 125	5 515	4 900	<b>4 375</b>	3 940	<b>3.00</b>
	<b>16 PR</b>	163 A8	4 780	4 305	3 825	3 415	3 075	1.50
			5 125	4 610	4 100	3 660	3 295	1.70
			5 455	4 910	4 360	3 895	3 505	1.90
			5 775	5 200	4 620	4 125	3 715	2.10
			6 235	5 615	4 990	4 455	4 010	2.40
			6 530	5 880	5 225	4 665	4 200	2.60
	6 825	6 145	5 460	<b>4 875</b>	4 390	<b>2.80</b>		



TR-01

Tread pattern with excellent traction, suitable for all self-propelled machines, agricultural loaders, small dump trucks and telescopic loaders.



TR-03

Universal traction pattern for different agricultural applications.



TR-04

All-round tread pattern with great traction for a wide range of agricultural uses.



TR-05

Time proven pattern for agricultural application with very good traction.



TR-06

Low-profile traction pattern for use in meadowlands, suitable for drive wheels.



TR-07

Low-profile tread pattern with great traction, recommended for meadowland use.



TR-08

Flotation pattern with reduced soil compaction due to low inflation pressure. Great traction, breaking performance and lateral stability.



TR-09

Traction pattern suitable for front wheels of backhoe loaders and wheel loaders.

# TR series – Implement Diagonal Traction tyres for wide agricultural application



**TR-10**

Tread pattern suitable above all for **bigger skid-steer loaders or self-propelled plat-forms**. Recommended also for front wheels of back-hoe loaders.



**TR-11**

Tread pattern with robust lugs, ensuring very good traction. Suitable for **loaders and side dumpers**.



**TR-12**

Pattern with excellent traction, developed for **powered wheels of agricultural and industrial machinery**. Applicable for trailed wheels as well.

Tyre size	TR-01	TR-03	TR-04	TR-05	TR-06	TR-07	TR-08	TR-11	TR-12
31x15.50-15					•	•			
10.0/75-15.3		•	•						
11.5/80-15.3		•							
400/60-15.5							•		
15.0/55-17	•								
12.0/75-18		•						•	
14.5/80-18				•					
400/70-20	•								
500/45-20									•
500/60-22.5							•		•
550/60-22.5							•		
600/40-22.5									•
600/50-22.5									



## TR series

### Technical data and load capacities

Tyre size	Tread pattern	Type	Rim (permitted)	Tube	Section width (mm)	Overall diameter (mm)	Loaded static radius (mm)	Rolling circumference (mm)
<b>31×15.50-15</b> (400/50-15)	TR-06	TL	13LB×15	-	370	760	350	2 235
<b>31×15.50-15</b> (400/50-15)	TR-07	TL	13LB×15	-	370	760	350	2 235
<b>10.0/75-15.3</b>	TR-03	TL	9.00×15.3	10-15 HS 10/75-15	264	780	360	2 295
<b>10.0/75-15.3</b>	TR-03	TL	9.00×15.3	10-15 HS 10/75-15	264	780	360	2 295
<b>10.0/75-15.3</b>	TR-03	TL	9.00×15.3	10-15 HS 10/75-15	264	780	360	2 295
<b>10.0/75-15.3</b>	TR-04	TT/TL	9.00×15.3	10-15 HS 10/75-15	264	780	360	2 295
<b>11.5/80-15.3</b>	TR-03	TL	9.00×15.3	11.5/80-15	290	867	395	2 550
<b>11.5/80-15.3</b>	TR-03	TT/TL	9.00×15.3	11.5/80-15	290	867	395	2 550
<b>400/60-15.5</b>	TR-08	TL	13.00×15.5	-	390	865	385	2 546
<b>400/60-15.5</b>	TR-08	TL	13.00×15.5	-	390	865	385	2 546



	Ply rating PR	Service description L/SS	Tyre load capacity (kg) – free rolling / drive wheel – at speed (km/h)					Tyre pressure (bar)
			10	20	30	40	50	
<b>8 PR</b>	121/109 A8	1 045 / 730	940 / 655	835 / 580	745 / 520	670 / 470	1.00	
		1 295 / 910	1 165 / 820	1 035 / 730	925 / 650	835 / 585	1.50	
		1 555 / 1 090	1 400 / 985	1 245 / 875	1 110 / 780	1 000 / 700	2.00	
		1 805 / 1 265	1 625 / 1 140	1 445 / 1 015	1 290 / 905	1 160 / 815	2.50	
		2 030 / 1 440	1 825 / 1 300	1 625 / 1 155	<b>1 450 / 1 030</b>	1 305 / 925	<b>3.00</b>	
<b>8 PR</b>	121/109 A8	1 045 / 730	940 / 655	835 / 580	745 / 520	670 / 470	1.00	
		1 295 / 910	1 165 / 820	1 035 / 730	925 / 650	835 / 585	1.50	
		1 555 / 1 090	1 400 / 985	1 245 / 875	1 110 / 780	1 000 / 700	2.00	
		1 805 / 1 265	1 625 / 1 140	1 445 / 1 015	1 290 / 905	1 160 / 815	2.50	
		2 030 / 1 440	1 825 / 1 300	1 625 / 1 155	<b>1 450 / 1 030</b>	1 305 / 925	<b>3.00</b>	
<b>10 PR</b>	122/111 A8	1 665 / 1 210	1 500 / 1 090	1 335 / 970	1 190 / 865	1 070 / 780	2.50	
		1 755 / 1 275	1 580 / 1 145	1 405 / 1 020	1 255 / 910	1 130 / 820	2.75	
		1 850 / 1 330	1 665 / 1 195	1 480 / 1 065	1 320 / 950	1 190 / 855	3.00	
		1 910 / 1 380	1 720 / 1 240	1 530 / 1 105	1 365 / 985	1 230 / 885	3.25	
		1 975 / 1 430	1 775 / 1 285	1 580 / 1 140	1 410 / 1 020	1 270 / 920	3.50	
2 100 / 1 525	1 890 / 1 375	1 680 / 1 220	<b>1 500 / 1 090</b>	1 350 / 980	<b>4.00</b>			
<b>12 PR</b>	125/114 A8	2 170 / 1 570	1 955 / 1 410	1 735 / 1 255	1 550 / 1 120	1 395 / 1 010	4.25	
		2 240 / 1 610	2 015 / 1 450	1 790 / 1 290	1 600 / 1 150	1 440 / 1 035	4.50	
<b>14 PR</b>	130/118 A8	2 310 / 1 650	2 080 / 1 485	1 850 / 1 320	<b>1 650 / 1 180</b>	1 485 / 1 060	<b>4.75</b>	
		2 430 / 1 715	2 185 / 1 545	1 945 / 1 370	1 735 / 1 225	1 560 / 1 105	5.00	
<b>14 PR</b>	130/118 A8	2 550 / 1 780	2 295 / 1 600	2 040 / 1 420	1 820 / 1 270	1 640 / 1 145	5.25	
		2 660 / 1 850	2 395 / 1 665	2 130 / 1 480	<b>1 900 / 1 320</b>	1 710 / 1 190	<b>5.50</b>	
<b>10 PR</b>	122/111 A8	1 665 / 1 210	1 500 / 1 090	1 335 / 970	1 190 / 865	1 070 / 780	2.50	
		1 755 / 1 275	1 580 / 1 145	1 405 / 1 020	1 255 / 910	1 130 / 820	2.75	
		1 850 / 1 330	1 665 / 1 195	1 480 / 1 065	1 320 / 950	1 190 / 855	3.00	
		1 910 / 1 380	1 720 / 1 240	1 530 / 1 105	1 365 / 985	1 230 / 885	3.25	
		1 975 / 1 430	1 775 / 1 285	1 580 / 1 140	1 410 / 1 020	1 270 / 920	3.50	
2 100 / 1 525	1 890 / 1 375	1 680 / 1 220	<b>1 500 / 1 090</b>	1 350 / 980	<b>4.00</b>			
<b>10 PR</b>	130/119 A8	1 820 / 1 510	1 640 / 1 360	1 455 / 1 210	1 300 / 1 080	1 170 / 970	2.25	
		2 065 / 1 580	1 860 / 1 425	1 650 / 1 265	1 475 / 1 130	1 330 / 1 015	2.50	
		2 430 / 1 735	2 185 / 1 560	1 945 / 1 390	1 735 / 1 240	1 560 / 1 115	3.00	
		2 660 / 1 905	2 395 / 1 715	2 130 / 1 525	<b>1 900 / 1 360</b>	1 710 / 1 225	<b>3.50</b>	
<b>14 PR</b>	139/126 A8	2 970 / 2 170	2 670 / 1 955	2 375 / 1 735	2 120 / 1 550	1 910 / 1 395	4.00	
		3 260 / 2 310	2 935 / 2 080	2 610 / 1 850	2 330 / 1 650	2 095 / 1 485	4.50	
		3 400 / 2 380	3 060 / 2 140	2 720 / 1 905	<b>2 430 / 1 700</b>	2 185 / 1 530	<b>4.75</b>	
<b>14 PR</b>	140/127 A8	2 015 / 1 420	1 815 / 1 280	1 615 / 1 135	1 440 / 1 015	1 295 / 915	1.25	
		2 185 / 1 525	1 965 / 1 375	1 745 / 1 220	1 560 / 1 090	1 405 / 980	1.50	
		2 520 / 1 750	2 270 / 1 575	2 015 / 1 400	1 800 / 1 250	1 620 / 1 125	2.00	
		2 800 / 1 975	2 520 / 1 775	2 240 / 1 580	2 000 / 1 410	1 800 / 1 270	2.50	
		3 150 / 2 205	2 835 / 1 985	2 520 / 1 765	2 250 / 1 575	2 025 / 1 420	3.00	
3 500 / 2 450	3 150 / 2 205	2 800 / 1 960	<b>2 500 / 1 750</b>	2 250 / 1 575	<b>3.50</b>			
(4)	145/132 A8	4 060 / 2 800	3 650 / 2 520	3 250 / 2 240	<b>2 900 / 2 000</b>	2 610 / 1 800	<b>3.60</b>	



## TR series (continued)

### Technical data and load capacities

Tyre size	Tread pattern	Type	Rim (permitted)	Tube	Section width (mm)	Overall diameter (mm)	Loaded static radius (mm)	Rolling circumference (mm)	
<b>400/60 - 15.5</b>	TR-08	TL	13.00×15.5	-	390	865	385	2 546	
<b>15.0/55 - 17</b>	TR-01	TL	13.00×17 (13×17)	-	391	872	410	2 565	
<b>15.0/55 - 17</b>	TR-01	TL	13.00×17 (13×17)	-	391	872	410	2 565	
<b>15.0/55 - 17</b>	TR-01	TL	13.00×17	-	391	872	410	2 565	
<b>480/45 - 17 IMP</b>	TR-01	TL	15.00×17 (16.00×17)	-	479	864	410	2 576	
<b>14 - 17.5</b>	TR-10	TL	10.50×17.5	-	355	910	430	2 858	
<b>14 - 17.5</b>	TR-10	TL	10.50×17.5	-	355	910	430	2 858	
<b>12.0/75 - 18</b>	TR-03	TL	W9×18 (9.11×18)	12.0-18	299	937	447	2 755	
<b>12.0/75 - 18</b>	TR-11	TL	W9×18 (9.11×18)	12.0-18	299	937	447	2 755	
<b>14.5/80 - 18</b>	TR-05	TT	13×18	14.5/80-18	372	1 045	475	3 075	
<b>500/45 - 20</b>	TR-12	TL	16.00×20 DC	-	490	980	445	2 910	



	Ply rating PR	Service description L/SS	Tyre load capacity (kg) – free rolling / drive wheel – at speed (km/h)					Tyre pressure (bar)
			10	20	30	40	50	
		152/140 A8	4410 / 3135 4690 / 3305 4970 / 3500	3970 / 2820 4220 / 2975 4475 / 3150	3530 / 2510 3750 / 2645 3975 / 2800	3150 / 2240 3350 / 2360 <b>3550 / 2500</b>	2835 / 2015 3015 / 2125 3195 / 2250	<b>4.00</b> <b>5.00</b> <b>6.00</b>
	<b>10 PR</b>	131/119 A8	2 325 / 1 615 2 465 / 1 710 2 595 / 1 815 2 730 / 1 905	2 090 / 1 455 2 220 / 1 535 2 335 / 1 630 2 455 / 1 715	1 860 / 1 295 1 970 / 1 365 2 080 / 1 450 2 185 / 1 525	1 660 / 1 155 1 760 / 1 220 1 855 / 1 295 <b>1 950 / 1 360</b>	1 495 / 1 040 1 585 / 1 100 1 670 / 1 165 1 755 / 1 225	2.00 2.20 2.40 <b>2.60</b>
	<b>12 PR</b>	134/122 A8	2 830 / 1 990 2 970 / 2 100	2 545 / 1 790 2 670 / 1 890	2 260 / 1 590 2 375 / 1 680	2 020 / 1 420 <b>2 120 / 1 500</b>	1 820 / 1 280 1 910 / 1 350	2.80 <b>3.10</b>
	<b>14 PR</b>	137/125A8	3 050 / 2 135 3 135 / 2 200 3 220 / 2 310	2 745 / 1 920 2 820 / 1 980 2 900 / 2 080	2 440 / 1 710 2 510 / 1 760 2 575 / 1 850	2 180 / 1 525 2 240 / 1 570 <b>2 300 / 1 650</b>	1 960 / 1 370 2 015 / 1 415 2 070 / 1 485	3.30 3.50 <b>3.70</b>
	-	146/134 A8	1 638 / 1 158 2 100 / 1 484 2 604 / 1 840 2 982 / 2 107 3 444 / 2 434 3 906 / 2 760 4 200 / 2 968	1 474 / 1 042 1 890 / 1 336 2 344 / 1 656 2 684 / 1 897 3 100 / 2 190 3 515 / 2 484 3 780 / 2 671	1 310 / 926 1 680 / 1 187 2 083 / 1 472 2 386 / 1 686 2 755 / 1 947 3 125 / 2 208 3 360 / 2 374	1 170 / 827 1 500 / 1 060 1 860 / 1 314 2 130 / 1 505 2 460 / 1 738 2 790 / 1 972 <b>3 000 / 2 120</b>	1 053 / 744 1 350 / 954 1 674 / 1 183 1 917 / 1 355 2 214 / 1 565 2 511 / 1 774 2 700 / 1 908	0.80 1.20 1.60 2.00 2.40 2.80 <b>3.20</b>
	<b>14PR</b>	150B/139B	5 210 / 3 780	4 685 / 3 400	4 166 / 3 025	3 720 / 2 700	<b>3 350 / 2 430</b>	<b>5.50</b>
	<b>14 PR</b>	150/139 B	3 890 / 2 760 4 060 / 2 890 4 240 / 3 030 4 410 / 3 165 4 640 / 3 345 4 930 / 3 565 5 210 / 3 780	3 505 / 2 480 3 655 / 2 600 3 820 / 2 730 3 970 / 2 850 4 175 / 3 010 4 435 / 3 205 4 685 / 3 400	3 115 / 2 205 3 250 / 2 315 3 395 / 2 425 3 530 / 2 530 3 715 / 2 675 3 940 / 2 850 4 166 / 3 025	2 780 / 1 970 2 900 / 2 065 3 030 / 2 165 3 150 / 2 260 3 315 / 2 390 3 520 / 2 545 3 720 / 2 700	2 500 / 1 775 2 610 / 1 860 2 725 / 1 950 2 835 / 2 035 2 985 / 2 150 3 170 / 2 290 <b>3 350 / 2 430</b>	3.20 3.50 3.80 4.10 4.50 5.00 <b>5.50</b>
	<b>12 PR</b>	139/126 A8	3 150 / 2 225 3 400 / 2 380	2 835 / 2 005 3 060 / 2 140	2 520 / 1 780 2 720 / 1 905	2 250 / 1 590 <b>2 430 / 1 700</b>	2 025 / 1 430 2 185 / 1 530	3.50 <b>4.00</b>
	<b>12 PR</b>	135/123 A8	2 490 / 1 800 2 610 / 1 870 2 835 / 2 025 3 050 / 2 170	2 245 / 1 620 2 350 / 1 680 2 550 / 1 820 2 745 / 1 955	1 995 / 1 440 2 090 / 1 500 2 270 / 1 620 2 440 / 1 735	1 780 / 1 285 1 865 / 1 335 2 025 / 1 445 <b>2 180 / 1 550</b>	1 600 / 1 155 1 680 / 1 200 1 825 / 1 300 1 960 / 1 395	2.75 3.00 3.50 <b>4.00</b>
	<b>12 PR</b>	155/143 A8	3 765 / 2 660 4 445 / 3 155 4 895 / 3 485 5 425 / 3 815	3 390 / 2 395 4 000 / 2 840 4 405 / 3 135 4 885 / 3 435	3 015 / 2 130 3 555 / 2 525 3 915 / 2 790 4 340 / 3 050	2 690 / 1 900 3 175 / 2 255 3 495 / 2 490 <b>3 875 / 2 725</b>	2 420 / 1 710 2 860 / 2 030 3 145 / 2 240 3 490 / 2 455	2.50 3.25 3.75 <b>4.25</b>
		162/150 A8	5 775 / 4 060 6 125 / 4 305 6 650 / 4 690	5 200 / 3 655 5 510 / 3 875 5 985 / 4 220	4 620 / 3 250 4 900 / 3 445 5 320 / 3 750	4 125 / 2 900 4 375 / 3 075 <b>4 750 / 3 350</b>	3 710 / 2 610 3 940 / 2 770 4 275 / 3 015	4.00 5.00 6.00



## TR series (continued)

### Technical data and load capacities

Tyre size	Tread pattern	Type	Rim (permitted)	Tube	Section width (mm)	Overall diameter (mm)	Loaded static radius (mm)	Rolling circumference (mm)	
500/60 - 22.5	TR-08	TL	16.00×22.5	-	503	1 192	519	3 504	
500/60 - 22.5	TR-12	TL	16.00×22.5 DC	-	503	1 192	519	3 504	
500/60 - 22.5	TR-12	TL	16.00×22.5	-	503	1 192	519	3 504	
550/60 - 22.5	TR-08	TL	16.00×22.5	-	537	1 254	542	3 687	
550/60 - 22.5	TR-08	TL	16.00×22.5	-	537	1 254	542	3 687	
600/40 - 22.5	TR-12	TL	20.00TH2×22.5 (20.00DC)	-	600	1 050	473	3 146	
600/40 - 22.5	TR-12	TL	20.00TH2×22.5 (20.00DC)	-	600	1 050	473	3 146	
600/50 - 22.5	TR-08	TL	20.00×22.5	-	595	1 140	510	3 380	
600/50 - 22.5	TR-08 HD	TL	20.00×22.5	-	611	1 172	510	3 440	

<sup>1)</sup> Reinforced version (REINFORCED)

For Non-standard version, please contact a producer.  
These tyres are for normal agricultural use and not for continuous highway service.





	Ply rating PR	Service description L/SS	Tyre load capacity (kg) – free rolling / drive wheel – at speed (km/h)					Tyre pressure (bar)	
			10	20	30	40	50		
16 PR	159/147 A8	3 955 / 2 700	3 560 / 2 430	3 165 / 2 160	2 825 / 1 930	2 545 / 1 735	1.50		
		4 390 / 3 050	3 950 / 2 745	3 510 / 2 440	3 135 / 2 180	2 820 / 1 960	1.80		
		4 825 / 3 390	4 340 / 3 050	3 860 / 2 710	3 445 / 2 420	3 100 / 2 180	2.10		
		5 250 / 3 710	4 725 / 3 340	4 200 / 2 970	3 750 / 2 650	3 375 / 2 385	2.40		
		5 690 / 4 010	5 120 / 3 610	4 555 / 3 210	4 065 / 2 865	3 660 / 2 580	2.70		
		6 125 / 4 305	5 515 / 3 875	4 900 / 3 445	<b>4 375 / 3 075</b>	3 940 / 2 770	<b>3.00</b>		
	165/153 A8	6125 / 4305	5510 / 3875	4900 / 3445	4375 / 3075	3940 / 2770	2.80		
		6650 / 4690	5985 / 4220	5320 / 3750	4750 / 3350	4275 / 3015	3.20		
		7210 / 4970	6490 / 4475	5780 / 3975	<b>5150 / 3550</b>	4635 / 3195	<b>3.60</b>		
	170/158 A8	7 840 / 5 600	7 055 / 5 040	6 270 / 4 480	5 600 / 4 000	5 040 / 3 600	4.00		
		8 400 / 5 950	7 560 / 5 355	6 720 / 4 760	<b>6 000 / 4 250</b>	5 400 / 3 825	<b>4.50</b>		
16 PR	167/155 A8	3 205 / 2 279	2 884 / 2 051	2 564 / 1 823	2 289 / 1 628	2 060 / 1 465	0.80		
		4 120 / 2 930	3 708 / 2 637	3 296 / 2 344	2 943 / 2 093	2 649 / 1 883	1.20		
		5 036 / 3 581	4 532 / 3 222	4 029 / 2 864	3 597 / 2 558	3 237 / 2 302	1.60		
		5 799 / 4 123	5 219 / 3 711	4 639 / 3 298	4 142 / 2 945	3 728 / 2 651	2.00		
		6 714 / 4 774	6 043 / 4 297	5 372 / 3 819	4 796 / 3 410	4 316 / 3 069	2.40		
		7 630 / 5 425	6 867 / 4 883	6 104 / 4 340	<b>5 450 / 3 875</b>	4 905 / 3 488	<b>2.80</b>		
				7 060 / 4 940	6 495 / 4 540	5 930 / 4 150	5 650 / 3 950	4 800 / 3 360	3.00
	171/159 A8	7 360 / 5 220	6 775 / 4 800	6 185 / 4 385	5 890 / 4 175	5 005 / 3 550	3.20		
		7 700 / 5 470	7 070 / 5 030	6 500 / 4 640	<b>6 150 / 4 375</b>	5 225 / 3 720	<b>3.40</b>		
	161/149 A8	2 520 / 1 750	2 270 / 1 575	2 015 / 1 400	1 800 / 1 250	1 620 / 1 125	0.80		
		3 220 / 2 310	2 900 / 2 080	2 575 / 1 850	2 300 / 1 650	2 070 / 1 485	1.20		
		3 920 / 2 800	3 530 / 2 520	3 135 / 2 240	2 800 / 2 000	2 520 / 1 800	1.60		
		4 550 / 3 220	4 095 / 2 900	3 640 / 2 575	3 250 / 2 300	2 925 / 2 070	2.00		
		5 250 / 3 710	4 725 / 3 340	4 200 / 2 970	3 750 / 2 650	3 375 / 2 385	2.40		
		5 950 / 4 200	5 355 / 3 780	4 760 / 3 360	4 250 / 3 000	3 825 / 2 700	2.80		
		6 475 / 4 550	5 830 / 4 095	5 180 / 3 640	<b>4 625 / 3 250</b>	4 160 / 2 925	<b>3.20</b>		
	172/160 A8	7 000 / 4 970	6 300 / 4 475	5 600 / 3 975	5 000 / 3 550	4 500 / 3 195	3.60		
		7 840 / 5 600	7 055 / 5 040	6 270 / 4 480	5 600 / 4 000	5 040 / 3 600	4.00		
		8 120 / 5 775	7 310 / 5 200	6 495 / 4 620	<b>5 800 / 4 125</b>	5 220 / 3 710	5.00		
		8 820 / 6 300	7 940 / 5 670	7 055 / 5 040	<b>6 300 / 4 500</b>	5 670 / 4 050	<b>6.00</b>		
16 PR	165/153 A8	4 440 / 3 025	3 995 / 2 720	3 550 / 2 420	3 170 / 2 160	2 855 / 1 945	1.10		
		4 830 / 3 305	4 345 / 2 975	3 865 / 2 645	3 450 / 2 360	3 105 / 2 125	1.30		
		5 395 / 3 690	4 855 / 3 320	4 320 / 2 950	3 855 / 2 635	3 470 / 2 370	1.60		
		5 760 / 3 940	5 185 / 3 545	4 610 / 3 155	4 115 / 2 815	3 705 / 2 535	1.80		
		6 125 / 4 200	5 515 / 3 780	4 900 / 3 360	4 375 / 3 000	3 940 / 2 700	2.00		
		6 670 / 4 650	6 005 / 4 185	5 335 / 3 720	4 765 / 3 320	4 290 / 2 990	2.30		
		7 210 / 5 110	6 490 / 4 600	5 770 / 4 090	<b>5 150 / 3 650</b>	4 635 / 3 285	<b>2.60</b>		
				7 840 / 5 600	7 055 / 5 040	6 270 / 4 480	<b>5 600 / 4 000</b>	5 040 / 3 600	<b>3.20</b>



**TS-01**

Classic tread pattern with excellent traction.



**TS-02**

Universal traction pattern for a wide range of gardening applications.



**TS-03**

Tread pattern with deep and robust lugs for greater traction.



**TS-04**

All-round tread pattern with excellent traction.



**TS-05**

Pattern with very good traction and handling. Also suitable for light industrial use.



**TS-06**

Improved tread pattern with great traction.



**TS-07**

Pattern specially developed for seed drill machines for soil compaction. Applicable for drive wheels as well.



**TD-10**

Lugged tread pattern for powered axle.

# Tractor small tyres

For all kinds of gardening equipment

---



**TD-13**

A classic tread pattern design, well-tested and proven.



**B 12**

Universal traction pattern for a wide range of gardening applications.



**B 16**

Tread pattern with deep and robust lugs for greater traction.



**B 17**

Lugged tread pattern with excellent traction.



**B 18**

Universal tread pattern with great traction.



**B 64**

Universal traction pattern for a wide range of gardening applications.

# Tractor Small Tyres

## Technical data and load capacities

Tyre size	Tread pattern	Type	Rim (permitted)	Tube	Section width (mm)	Overall diameter (mm)	Loaded static radius (mm)	Rolling circumference (mm)
<b>3.50-6</b>	B 16	TT	2.50×6	4.00-6	96	343	157	1 026
<b>13×5.00-6</b>	B 12	TT/TL	3.50×6	4.00-6	120	328	151	981
<b>3.50-8</b>	B 16	TT	2.50×8	3.50/4.00-8	96	395	183	1 181
<b>4.00-8</b>	TS-01	TT	3.00D×8	4.00-8	114	425	195	1 250
<b>4.00-8</b>	B 12	TT	3.00×8	3.50/4.00-8	105	425	196	1 271
<b>4.00-8</b>	B 12	TT	3.00×8	3.50/4.00-8	105	425	196	1 271
<b>16×6.50-8</b>	B 64	TT/TL	5.375×8	16×6.50/7.50-8	165	408	189	1 220
<b>16×6.50-8</b>	B 64	TT/TL	5.375×8	16×6.50/7.50-8	165	408	189	1 220
<b>4.00-10</b>	B 12	TT	3.00×10	4.00-10	109	470	219	1 405
<b>4.00-10</b>	B 12	TTT	3.00×10	4.00-10	109	470	219	1 405
<b>4.0-10</b>	TS-03	TT	3.50B×10 (3.00B×10)	4.0-10	114	463	214	1 370
<b>4.0-10</b>	B 17	TT	3.50×10	4.00-10	111	460	215	1 375
<b>5.00-10</b>	B 16	TT	3.00×10	5.00-10	132	520	240	1 555
<b>5.0-10</b>	TS-03	TT	4J×10 (3.50B×10)	5.0-10	140	512	234	1 520
<b>5.0-10</b>	TS-03	TT	4J×10 (3.50B×10)	5.0-10	140	512	234	1 520
<b>5.0-10</b>	B 17	TT	3.50×10	5.00-10	135	515	238	1 540
<b>5.0-10</b>	B 17	TT	3.50×10	5.00-10	135	515	238	1 540
<b>4.00-12</b>	B 12	TT	3.00×12	4.00-12	109	530	248	1 585
<b>5.00-12</b>	TS-02	TT	4.00E×12 (3.00D×12)	5.00-12	145	580	260	1 705
<b>5.00-12</b>	TS-02	TT	4.00E×12 (3.00D×12)	5.00-12	145	580	260	1 705
<b>5.00-12</b>	TS-02	TT	4.00E×12 (3.00D×12)	5.00-12	145	580	260	1 705
<b>5.00-12</b>	B 12	TT	4.00×12	5.00-12	145	575	267	1 719
<b>5.00-12</b>	B 12	TT	4.00×12	5.00-12	145	575	267	1 719



	Ply rating PR	Service description L/SS	Tyre load capacity (kg) – free rolling / drive wheel – at speed (km/h)					Tyre pressure (bar)
			10	20	25	30	40	
	<b>4 PR</b>	33 A6	- / 148	- / 131	- / 123	- / <b>115</b>		<b>3.00</b>
	<b>4 PR</b>	49 A6	- / 239	- / 211	- / 198	- / <b>185</b>		<b>2.25</b>
	<b>4 PR</b>	35 A6	- / 156	- / 138	- / 129	- / <b>121</b>		<b>3.00</b>
	<b>2 PR</b> <sup>1)</sup>	43/31 A6	130 / 90	115 / 80	105 / 75	100 / 70	90 / 65	0.80
			175 / 125	155 / 110	145 / 100	135 / 95	120 / 90	1.00
			200 / 140	175 / 125	165 / 115	<b>155 / 109</b>	140 / 100	<b>1.50</b>
	<b>2 PR</b>	31 A6	- / 141	- / 124	- / 117	- / <b>109</b>		<b>1.50</b>
	<b>4 PR</b>	44 A6	- / 206	- / 182	- / 171	- / <b>160</b>		<b>2.75</b>
	<b>4 PR</b>	52 A6	- / 258	- / 228	- / 214	- / <b>200</b>		<b>1.90</b>
	<b>8 PR</b>	69 A6	- / 419	- / 371	- / 348	- / <b>325</b>		<b>4.25</b>
	<b>2 PR</b>	37 A6	- / 165	- / 146	- / 137	- / <b>128</b>		<b>1.50</b>
	<b>4 PR</b>	49 A6	- / 239	- / 211	- / 198	- / <b>185</b>		<b>2.75</b>
	<b>4 PR</b>	49/37 A8	205 / 150	185 / 135	175 / 125	160 / 115	145 / 105	0.80
			215 / 155	195 / 135	185 / 130	170 / 120	155 / 109	1.00
			225 / 165	200 / 145	190 / 135	180 / 125	160 / 115	1.25
			230 / 165	210 / 155	195 / 140	185 / 130	165 / 120	1.50
			260 / 180	235 / 160	220 / 150	200 / 145	<b>185 / 128</b>	<b>1.90</b>
	<b>2 PR</b>	40 A6	- / 181	- / 160	- / 150	- / <b>140</b>		<b>1.50</b>
	<b>4 PR</b>	59 A6	- / 313	- / 277	- / 260	- / <b>243</b>		<b>2.25</b>
	<b>2 PR</b>	57/44 A8	285 / 205	260 / 185	245 / 175	230 / 160	205 / 145	0.80
			320 / 225	290 / 200	275 / 195	255 / 180	<b>230 / 160</b>	<b>1.00</b>
	<b>4 PR</b>	70/58 A8	355 / 255	320 / 230	305 / 225	285 / 205	255 / 185	1.25
			400 / 280	360 / 255	340 / 240	315 / 225	285 / 200	1.50
			470 / 330	420 / 295	400 / 280	375 / 265	<b>335 / 236</b>	<b>2.00</b>
	<b>2 PR</b>	48 A6	- / 232	- / 205	- / 193	- / <b>180</b>		<b>1.25</b>
	<b>4 PR</b>	61 A6	- / 332	- / 293	- / 275	- / <b>257</b>		<b>2.25</b>
	<b>4 PR</b>	54 A6	- / 273	- / 242	- / 227	- / <b>212</b>		<b>2.75</b>
	<b>2 PR</b>	61/48 A6	290 / 200	255 / 180	240 / 165	225 / 155	205 / 140	1.00
			330 / 230	295 / 205	275 / 195	<b>257 / 180</b>	230 / 165	<b>1.25</b>
	<b>4 PR</b>	74/62 A6	370 / 260	325 / 230	305 / 215	285 / 200	255 / 180	1.50
			405 / 295	360 / 260	335 / 245	315 / 225	285 / 205	1.75
			445 / 320	395 / 280	370 / 260	<b>345 / 245</b>	310 / 225	<b>2.00</b>
	<b>6 PR</b>	78/66 A6	485 / 340	430 / 300	400 / 285	375 / 265	340 / 240	2.25
			495 / 350	440 / 310	410 / 290	385 / 270	345 / 245	2.50
			520 / 370	460 / 325	435 / 305	405 / 285	365 / 260	3.00
			550 / 390	485 / 345	455 / 325	<b>425 / 300</b>	385 / 270	<b>3.50</b>
			<b>2 PR</b>	48 A6	- / 232	- / 205	- / 193	- / <b>180</b>
	<b>4 PR</b>	62 A6	- / 342	- / 302	- / 284	- / <b>265</b>		<b>2.25</b>

## Tractor Small Tyres (continued)

### Technical data and load capacities

Tyre size	Tread pattern	Type	Rim (permitted)	Tube	Section width (mm)	Overall diameter (mm)	Loaded static radius (mm)	Rolling circumference (mm)
<b>6.5/90-12</b> (170/90-12)	TS-06	TT	5J×12 (5JA×12)	6.5/80-12	165	615	278	1 810
<b>6.5/90-12</b> (170/90-12)	TS-06	TT	5J×12 (5JA×12)	6.5/80-12	165	615	278	1 810
<b>6.5/80-12</b>	B 18	TT	5.00×12	5.00-12	165	600	278	1 794
<b>11.0/65-12</b>	TD-10	TT	9.00×12 <b>(7.00×12)</b>	-	281 261	692	310	2 125
<b>6.5/75-14</b>	TS-02	TT	5J×14	155/165-14	150	610	283	1 830
<b>5.00-15</b>	TS-06	TT	3,00D×15 (4J×15)	5.00-15	129	661	307	1 985
<b>5.00-15</b>	TS-06	TT	3,00D×15 (4J×15)	5.00-15	129	661	307	1 985
<b>6.5/90-15</b> (170/90-15)	TS-06	TT	5J×15 (41/2K×15)	6.5/80-15	163	695	318	2 040
<b>6.5/90-15</b> (170/90-15)	TS-06	TT	5J×15 (41/2K×15)	6.5/80-15	163	695	318	2 040
<b>6.5/90-15</b> (170/90-15)	TS-06	TT	5J×15 (41/2K×15)	6.5/80-15	163	695	318	2 040
<b>690×180-15</b>	TS-07	TT	5J×15		176	690	309	2 056
<b>10.0/75-15.3</b>	TS-05	TL	9.00×15.3	10-15 HS 10/75-15	264	780	360	2 295



	Ply rating PR	Service description LI/SS	Tyre load capacity (kg) – free rolling / drive wheel – at speed (km/h)					Tyre pressure (bar)
			10	20	25	30	40	
4 PR	79/68 A8	365 / 265	330 / 235	310 / 225	290 / 210	260 / 188	0.80	
		400 / 285	360 / 255	340 / 240	315 / 225	285 / 202	1.00	
		430 / 305	385 / 275	365 / 260	345 / 245	307 / 218	1.20	
		475 / 345	430 / 310	405 / 290	375 / 275	340 / 245	1.50	
		555 / 405	500 / 365	470 / 345	440 / 325	395 / 288	2.00	
		610 / 440	550 / 395	520 / 375	500 / 355	<b>437 / 315</b>	<b>2.40</b>	
6 PR	89/76 A8	695 / 475	625 / 425	590 / 400	550 / 380	495 / 338	2.75	
		730 / 505	655 / 455	620 / 430	580 / 405	520 / 362	3.00	
		810 / 560	730 / 505	690 / 475	650 / 450	<b>580 / 400</b>	<b>3.50</b>	
4 PR	72 A6	- / 458	- / 405	- / 380	- / <b>355</b>		<b>2.40</b>	
8 PR		- / 820	- / 725	/ 680	- / 635		1.00	
		- / 1 160	- / 1 025	/ 965	- / 900		1.80	
		- / 1 380	- / 1 220	/ 1 145	- / 1 070		2.50	
		- / 1 445	- / 1 275	/ 1 200	- / 1 120		2.80	
		- / 1 640	- / 1 450	/ 1 355	- / <b>1 270</b>		<b>3.40</b>	
4 PR	72/60 A6	335 / 235	295 / 215	280 / 195	260 / 185	235 / 170	1.00	
		425 / 300	375 / 265	355 / 250	330 / 230	295 / 210	1.50	
		460 / 325	405 / 285	380 / 270	<b>355 / 250</b>	320 / 225	<b>1.70</b>	
4 PR	75/63 A8	396 / 270	357 / 243	337 / 230	315 / 218	283 / 193	1.25	
		434 / 300	391 / 270	369 / 255	344 / 241	310 / 214	1.50	
		507 / 357	456 / 321	431 / 303	402 / 288	362 / 255	2.00	
		542 / 381	488 / 343	461 / 324	425 / 307	<b>387 / 272</b>	<b>2.20</b>	
6 PR	84/71 A8	578 / 405	520 / 364	491 / 344	456 / 325	413 / 289	2.50	
		638 / 444	575 / 399	543 / 377	508 / 356	456 / 317	3.00	
		700 / 483	630 / 435	595 / 411	560 / 387	<b>500 / 345</b>	<b>3.50</b>	
4 PR	86/75 A8	435 / 310	390 / 280	370 / 265	345 / 250	310 / 222	0.80	
		475 / 335	430 / 300	405 / 285	375 / 270	340 / 239	1.00	
		495 / 350	445 / 315	420 / 300	400 / 280	355 / 250	1.20	
		600 / 435	540 / 395	510 / 370	475 / 350	430 / 312	1.50	
		650 / 475	585 / 425	555 / 400	515 / 380	465 / 338	1.80	
		705 / 515	635 / 460	600 / 435	560 / 410	505 / 367	2.10	
		740 / 540	670 / 485	630 / 460	600 / 430	<b>530 / 385</b>	<b>2.40</b>	
6 PR	94/82 A8	790 / 560	710 / 505	670 / 475	630 / 450	565 / 401	2.70	
		840 / 595	755 / 535	715 / 505	670 / 475	600 / 425	3.00	
		890 / 630	800 / 565	755 / 535	710 / 505	635 / 450	3.30	
		940 / 665	845 / 600	795 / 565	750 / 530	<b>670 / 475</b>	<b>3.60</b>	
8 PR	100/88 A8	1 010 / 710	910 / 640	860 / 600	810 / 565	720 / 505	4.00	
		1 065 / 740	960 / 670	905 / 630	850 / 595	760 / 530	4.40	
		1 120 / 785	1 010 / 705	950 / 670	895 / 630	<b>800 / 560</b>	<b>4.80</b>	
4 PR	100/88 A8	1 030 / 720	925 / 650	875 / 615	825 / 575	735 / 515	2.00	
		1 120 / 785	1 010 / 705	950 / 665	890 / 625	<b>800 / 560</b>	<b>2.50</b>	
8 PR	118/106 A8	1 665 / 1 210	1 500 / 1 090	1 415 / 1 030	1 335 / 970	1 190 / 865	2.50	
		1 850 / 1 330	1 665 / 1 195	1 570 / 1 130	1 480 / 1 065	<b>1 320 / 950</b>	<b>3.00</b>	

## Tractor Small Tyres (continued)

### Technical data and load capacities

Tyre size	Tread pattern	Type	Rim (permitted)	Tube	Section width (mm)	Overall diameter (mm)	Loaded static radius (mm)	Rolling circumference (mm)	
<b>10.0/75 - 15.3</b>	TS-05	TL	9.00×15.3	10 - 15 HS 10/75 - 15	264	780	360	2 295	
<b>11.5/80 - 15.3</b>	TS-05	TL	9.00×15.3	11.5/80 - 15	290	867	410	2 550	
<b>11.5/80 - 15.3</b>	TS-05	TL	9.00×15.3	11.5/80 - 15	290	867	410	2 550	
<b>6.00 - 16</b>	TS-04	TT	4.50E×16 (4.00E×16)	6.00 - 16	169	735	345	2 160	
<b>6.00 - 16</b>	TS-04	TT	4.50E×16 (4.00E×16)	6.00 - 16	169	735	345	2 160	
<b>6.00 - 16</b>	TD-13	TT	4.50E×16 (4.00E×16)	6.00 - 16	169	735	345	2 160	
<b>6.50 - 16</b>	TD-10	TL	4.50E×16 (4.00E) (5.00F)	-	179 174 184	773	360	2 280	
<b>7.50 - 16</b>	TS-04	TT/TL	5.50F×16 (5.00F, 6.00F)	7.50 - 16	205	803	375	2 360	
<b>7.50 - 16</b>	TS-04	TT/TL	5.50F×16 (5.00F, 6.00F)	7.50 - 16	205	803	375	2 360	
<b>7.50 - 16</b>	TD-13	TT	5.50F×16 (5.00F, 6.00F)	7.50 - 16	205	803	375	2 360	
<b>7.50 - 20</b>	TS-04	TT	5.50F×20 (6.00F×20)	7.50 - 20	205	904	420	2 660	
<b>7.50 - 20</b>	TD-13	TT	5.50F×20 (6.00F×20)	7.50 - 20	205	904	420	2 660	
<b>8.3 - 20</b>	TD-13	TT	W7×20 (W6×20)	8.3 - 20	211	895	416	2 640	

For Non-standard version, please contact a producer. <sup>1)</sup> Reinforced version also available (REINFORCED)





	Ply rating PR	Service description L/SS	Tyre load capacity (kg) – free rolling / drive wheel – at speed (km/h)					Tyre pressure (bar)
			10	20	25	30	40	
10 PR	122/111 A8	1 910 / 1 380	1 720 / 1 240	1 625 / 1 170	1 530 / 1 105	1 365 / 985	3.25	
		1 975 / 1 430	1 775 / 1 285	1 680 / 1 215	1 580 / 1 140	1 410 / 1 020	3.50	
		2 100 / 1 525	1 890 / 1 375	1 785 / 1 295	1 680 / 1 220	<b>1 500 / 1 090</b>	<b>4.00</b>	
10 PR	130/119 A8	1 820 / 1 510	1 640 / 1 360	1 545 / 1 285	1 455 / 1 210	1 300 / 1 080	2.25	
		2 065 / 1 580	1 860 / 1 425	1 755 / 1 345	1 650 / 1 265	1 475 / 1 130	2.50	
		2 430 / 1 735	2 185 / 1 560	2 065 / 1 475	1 945 / 1 390	1 735 / 1 240	3.00	
		2 660 / 1 905	2 395 / 1 715	2 260 / 1 620	2 130 / 1 525	<b>1 900 / 1 360</b>	<b>3.50</b>	
14 PR	139/126 A8	2 970 / 2 170	2 670 / 1 955	2 525 / 1 845	2 375 / 1 735	2 120 / 1 550	4.00	
		3 260 / 2 310	2 935 / 2 080	2 775 / 1 965	2 610 / 1 850	2 330 / 1 650	4.50	
		3 400 / 2 380	3 060 / 2 140	2 890 / 2 035	2 720 / 1 905	<b>2 430 / 1 700</b>	<b>4.75</b>	
6 PR	91/79 A8	625 / 440	560 / 395	530 / 375	500 / 350	445 / 315	1.50	
		730 / 520	655 / 465	620 / 440	580 / 410	520 / 370	2.00	
		820 / 580	735 / 525	695 / 495	655 / 460	585 / 415	2.50	
		860 / 610	775 / 550	730 / 520	690 / 490	<b>615 / 437</b>	<b>2.75</b>	
8 PR	100/88 A8	930 / 650	840 / 585	790 / 555	745 / 515	665 / 465	3.00	
		1 030 / 720	925 / 650	875 / 615	825 / 570	735 / 515	3.50	
		1 120 / 785	1 010 / 705	950 / 665	895 / 615	<b>800 / 560</b>	<b>4.00</b>	
6 PR	79 A8	- / 450	- / 395	- / 375	- / 350	- / 315	1.50	
		- / 530	- / 465	- / 440	- / 410	- / 370	2.00	
		- / 595	- / 525	- / 495	- / 460	- / 410	2.50	
		- / 630	- / 550	- / 520	- / 490	- / 440	<b>2.80</b>	
8 PR	99A8	- / 660	- / 625	- / 585	- / 545	- / 510	1.60	
		- / 850	- / 800	- / 750	- / 700	- / 655	2.40	
		- / 1 010	- / 955	- / 890	- / 830	- / 775	<b>3.20</b>	
6 PR	100/88 A8	905 / 630	815 / 565	770 / 535	720 / 500	645 / 450	1.50	
		1 065 / 740	960 / 665	905 / 630	850 / 585	760 / 525	2.00	
		1 120 / 785	1 010 / 705	950 / 665	895 / 630	<b>800 / 560</b>	<b>2.25</b>	
8 PR <sup>1)</sup>	108/95 A8	1 220 / 840	1 095 / 755	1 035 / 715	975 / 665	870 / 600	2.50	
		1 360 / 935	1 220 / 840	1 155 / 795	1 085 / 740	970 / 665	3.00	
		1 400 / 965	1 260 / 870	1 190 / 820	1 120 / 775	<b>1 000 / 690</b>	<b>3.25</b>	
6 PR	100/88 A8	905 / 630	815 / 565	770 / 535	720 / 500	645 / 450	1.50	
		1 065 / 740	960 / 665	905 / 630	850 / 585	760 / 525	2.00	
		1 120 / 785	1 010 / 705	950 / 665	895 / 630	<b>800 / 560</b>	<b>2.25</b>	
6 PR	103/91 A8	985 / 690	890 / 620	840 / 585	790 / 545	705 / 490	1.50	
		1 155 / 810	1 040 / 730	980 / 690	925 / 640	825 / 575	2.00	
		1 225 / 680	1 105 / 775	1 040 / 730	980 / 690	<b>875 / 615</b>	<b>2.25</b>	
6 PR	103/91 A8	985 / 690	890 / 620	840 / 585	790 / 545	705 / 490	1.50	
		1 155 / 810	1 040 / 730	980 / 690	925 / 640	825 / 575	2.00	
		1 225 / 680	1 105 / 775	1 040 / 730	980 / 690	<b>875 / 615</b>	<b>2.25</b>	
6 PR	104/92 A8	915 / 530	810 / 465	760 / 440	710 / 410	630 / 370	0.80	
		1 045 / 660	925 / 580	865 / 545	810 / 510	720 / 460	1.20	
		1 175 / 785	1 035 / 695	975 / 655	910 / 610	810 / 550	1.60	
		1 305 / 915	1 150 / 810	1 080 / 760	1 010 / 710	<b>900 / 630</b>	<b>2.00</b>	

These tyres are for normal agricultural use and not for continuous highway service.



**TF-01**

Multi-rib tread profile without any lateral tread elements and side lugs.



**TF-02**

Multi-rib tread pattern with short, strong shoulder lugs. Secure track holding and good climbing capabilities when steering out of the furrow.



**TF-03**

Multi-rib tread pattern with very strong shoulder lugs and lateral tread elements.



**TF-04**

Pattern with high stability in track due to deep relief of design.



**TF-05**

Designed for non-driven tractor wheels. Improved on-road performance and straight-line steering characteristics.



**TF-06**

Pattern with very long service life and excellent steering characteristics, mainly on soft terrain.

# Tractor front tyres with balanced properties

For perfect handling on and off the road



## IM-05

Special tread pattern developed for steering wheels of industrial tractors.

Tyre size	TF-01	TF-02	TF-03	TF-04	TF-05	TF-06	IM-05
4.00-16		•					
4.50-16		•					
5.00-16		•					
6.00-16	•	•	•			•	
6.50-16		•	•		•		
7.50-16	•	•	•		•		
9.00-16			•				
10.00-16			•				
11L-16							•
6.00-18			•	•			
6.50-20			•	•	•		
7.50-20	•		•		•		



# Tractor Front Tyres

## Technical data and load capacities

Tyre size	Tread pattern	Type	Rim (permitted)	Tube	Section width (mm)	Overall diameter (mm)	Loaded static radius (mm)	Rolling circumference (mm)	
<b>4.00-16</b>	TF-02	TT	3.00D×16	3.00-16	118	645	306	1 896	
<b>4.50-16</b>	TF-02	TT	3.00D×16	3.00-16	121	657	308	1 932	
<b>5.00-16</b>	TF-02	TT	3.50D×16 (4.00E×16)	3.50-16	138 143	679	318	1 996	
<b>6.00-16</b>	TF-01	TT	4.50E×16 (4.00E, 5K, 5.00F)	6.00-16	165	735	340	2 160	
<b>6.00-16</b>	TF-02	TT	4.50E×16 (4.00E,5K,5.00F)	6.00-16	169	739	344	2 173	
<b>6.00-16</b>	TF-03	TT	4.50E×16 (4.00E, 5K, 5.00F)	6.00-16	165	735	340	2 160	
<b>6.00-16</b>	TF-06	TT	4.50E×16 (4.00E, 5K, 5.00F)	6.00-16	165	735	340	2 160	
<b>6.50-16</b>	TF-02	TT	4.50E×16 (4.00E, 5K, 5.00F, 5.50F)	6.50-16	183	765	356	2 241	



	Ply rating PR	Service description LI/SS	Tyre load capacity (kg) at speed (km/h)				Tyre pressure (bar)
			10 *	20	30	40	
	<b>4 PR</b>	69 A6 (61 A8)	240	215	160	130	1.00
			350	320	235	190	2.00
			400	360	265	210	2.50
			490	440	<b>325</b>	260	<b>3.40</b>
	<b>4 PR</b>	73 A6 (65 A8)	255	255	190	150	1.00
			385	385	285	230	2.00
			490	440	325	260	2.50
			550	490	<b>365</b>	290	<b>3.10</b>
	<b>4 PR</b>	75 A6 (67 A8)	320	290	215	170	1.00
			405	365	270	215	1.50
			480	430	320	255	2.00
			580	520	<b>387</b>	310	<b>2.80</b>
	<b>6 PR</b>	88 A6 (80 A8)	445	400	295	235	1.00
			535	480	355	285	1.50
			630	565	420	335	2.00
			720	650	480	385	2.50
			805	720	535	430	3.00
			840	755	<b>560</b>	450	<b>3.30</b>
	<b>6 PR</b>	88 A6 (80 A8)	445	400	295	235	1.00
			535	480	355	285	1.50
			630	565	420	335	2.00
			720	650	480	385	2.50
			805	720	535	430	3.00
			840	755	<b>560</b>	450	<b>3.30</b>
	<b>6 PR</b>	88 A6 (80 A8)	445	400	295	235	1.00
			535	480	355	285	1.50
			630	565	420	335	2.00
			720	650	480	385	2.50
			805	720	535	430	3.00
			840	755	<b>560</b>	450	<b>3.30</b>
	<b>6 PR</b>	91 A6 (83 A8)	475	425	315	250	1.00
			580	520	385	310	1.50
			685	615	455	365	2.00
			790	710	525	420	2.50
			900	810	600	480	3.00
			925	830	<b>615</b>	485	<b>3.20</b>

## Tractor Front Tyres (continued)

### Technical data and load capacities

Tyre size	Tread pattern	Type	Rim (permitted)	Tube	Section width (mm)	Overall diameter (mm)	Loaded static radius (mm)	Rolling circumference (mm)	
6.50-16	TF-03	TT	4.50E×16 (4.00E, 5K, 5.00F, 5.50F)	6.50-16	175	760	350	2 230	
6.50-16	TF-03	TT	4.50E×16 (4.00E, 5K, 5.00F, 5.50F)	6.50-16	175	760	350	2 230	
6.50-16	TF-05	TT	4.50E×16 (4.00E, 5K, 5.00F, 5.50F)	6.50-16	175	760	350	2 230	
7.50-16	TF-01	TT	5.50F×16 (5.00F, 6.00F)	7.50-16	205	805	370	2 365	
7.50-16	TF-02	TT	5.50F×16 (5.00F, 6.00F)	7.50-16	218	820	383	2 398	
7.50-16	TF-02	TT	5.50F×16 (5.00F, 6.00F)	7.50-16	218	820	383	2 398	
7.50-16	TF-03	TT	5.50F×16 (5.00F, 6.00F)	7.50-16	205	805	370	2 365	
7.50-16	TF-03	TT	5.50F×16 (5.00F, 6.00F)	7.50-16	205	805	370	2 365	
7.50-16	TF-05	TT	5.50F×16 (5.00F, 6.00F)	7.50-16	205	805	370	2 365	
9.00-16	TF-03	TT	W8×16 (6.00F, W7, W8L)	9.00-16	234	855	395	2 514	



Ply rating PR	Service description LI/SS	Tyre load capacity (kg) at speed (km/h)				Tyre pressure (bar)
		10 *	20	30	40	
<b>6 PR</b>	91 A6 (83 A8)	475	425	315	250	1.00
		580	520	385	310	1.50
		685	615	455	365	2.00
		790	710	525	420	2.50
		900	810	600	480	3.00
		925	830	<b>615</b>	485	<b>3.20</b>
<b>8 PR</b>	97 A6 (89 A8)	1 065	960	710	560	4.00
		1 095	985	<b>730</b>	580	<b>4.20</b>
<b>6 PR</b>	91 A6 (83 A8)	475	425	315	250	1.00
		580	520	385	310	1.50
		685	615	455	365	2.00
		790	710	525	420	2.50
		900	810	600	480	3.00
		925	830	<b>615</b>	485	<b>3.20</b>
<b>6 PR</b>	98 A6 (90 A8)	780	700	520	415	1.50
		925	830	615	490	2.00
		1 050	945	700	560	2.50
		1 125	1 015	<b>750</b>	600	<b>2.80</b>
<b>6 PR</b>	98 A6 (90 A8)	780	700	520	415	1.50
		925	830	615	490	2.00
		1 050	945	700	560	2.50
		1 125	1 015	<b>750</b>	600	<b>2.80</b>
<b>8 PR</b>	103 A6 (96 A8)	1 160	1 045	775	620	3.10
		1 210	1 090	805	645	3.30
		1 260	1 135	840	670	3.50
		1 315	1 180	<b>875</b>	710	<b>3.70</b>
<b>6 PR</b>	98 A6 (90 A8)	780	700	520	415	1.50
		925	830	615	490	2.00
		1 050	945	700	560	2.50
		1 125	1 015	<b>750</b>	600	<b>2.80</b>
<b>8 PR</b>	103 A6 (96 A8)	1 160	1 045	775	620	3.10
		1 210	1 090	805	645	3.30
		1 260	1 135	840	670	3.50
		1 315	1 180	<b>875</b>	710	<b>3.70</b>
<b>6 PR</b>	98 A6 (90 A8)	780	700	520	415	1.50
		925	830	615	490	2.00
		1 050	945	700	560	2.50
		1 125	1 015	<b>750</b>	600	<b>2.80</b>
<b>6 PR</b>	104 A6 (97 A8)	835	750	555	445	1.00
		1 035	930	690	550	1.50
		1 245	1 120	830	665	2.00
		1 350	1 215	<b>900</b>	730	<b>2.30</b>

## Tractor Front Tyres (continued)

### Technical data and load capacities

Tyre size	Tread pattern	Type	Rim (permitted)	Tube	Section width (mm)	Overall diameter (mm)	Loaded static radius (mm)	Rolling circumference (mm)
<b>9.00-16</b>	TF-03	TT	W8×16 (6.00F, W7, W8L)	9.00-16	234	855	395	2 514
<b>10.00-16</b>	TF-03	TT/TL	W8×16 (W8L×16)	9.00-16 10.00-16	274	895	411	2 630
<b>11L-16</b>	IM-05 (F3)	TL	W8×16	-	285	805	372	2 365
<b>6.00-18</b>	TF-03	TT	4.50E×18 (4.00E, 5K, 5.00F)	6.00-18	160	790	365	2 323
<b>6.00-18</b>	TF-04	TT	4.50E×18 (4.00E, 5K, 5.00F)	6.00-18	160	790	365	2 323
<b>6.50-20</b>	TF-03	TT	5.00F×20 (4.00E, 5.50F)	6.50-20 7.00-20	175	865	408	2 543
<b>6.50-20</b>	TF-04	TT	5.00F×20 (4.00E, 5.50F)	6.50-20 7.00-20	175	865	408	2 543
<b>6.50-20</b>	TF-05	TT	5.00F×20 (4.00E, 5.50F)	6.50-20 7.00-20	175	865	408	2 543
<b>7.50-20</b>	TF-01	TT	5.50F×20 (5.00F, 6.00F)	7.50-20	205	915	420	2 690
<b>7.50-20</b>	TF-03	TT	5.50F×20 (5.00F, 6.00F)	7.50-20	205	915	420	2 690





	Ply rating PR	Service description LI/SS	Tyre load capacity (kg) at speed (km/h)				Tyre pressure (bar)
			10 *	20	30	40	
8 PR	111 A6 (103 A8)	1 450	1 300	965	770	2.50	
		1 510	1 355	1 005	805	2.70	
		1 570	1 410	1 045	835	2.90	
		1 635	1 470	<b>1 090</b>	875	<b>3.10</b>	
8 PR	118 A6 (114 A8)	1 075	895	715	645	1.00	
		1 335	1 110	890	800	1.50	
		1 585	1 320	1 055	950	2.00	
		1 835	1 530	1 220	1 100	2.50	
		1 970	1 640	<b>1 310</b>	1 180	<b>2.80</b>	
10 PR	119 A6 (115 A8)	1 150	1 035	920	820	2.00	
		1 365	1 230	1 090	975	2.50	
		1 520	1 365	1 215	1 085	3.00	
		1 660	1 495	1 325	1 185	3.50	
		1 700	1 530	<b>1 360</b>	1 215	<b>3.75</b>	
6 PR	96 A6 (88 A8)	705	635	470	375	2.00	
		855	770	570	455	2.50	
		1 005	905	670	535	3.00	
		1 065	960	<b>710</b>	560	<b>3.20</b>	
6 PR	96 A6 (88 A8)	705	635	470	375	2.00	
		855	770	570	455	2.50	
		1 005	905	670	535	3.00	
		1 065	960	<b>710</b>	560	<b>3.20</b>	
6 PR	97 A6 (89 A8)	795	715	530	425	2.00	
		930	835	620	495	2.50	
		1 060	950	705	565	3.00	
		1 095	985	<b>730</b>	580	<b>3.20</b>	
6 PR	97 A6 (89 A8)	795	715	530	425	2.00	
		930	835	620	495	2.50	
		1 060	950	705	565	3.00	
		1 095	985	<b>730</b>	580	<b>3.20</b>	
6 PR	97 A6 (89 A8)	795	715	530	425	2.00	
		930	835	620	495	2.50	
		1 060	950	705	565	3.00	
		1 095	985	<b>730</b>	580	<b>3.20</b>	
6 PR	103 A6 (96 A8)	880	790	585	470	1.50	
		1 050	945	700	560	2.00	
		1 215	1 095	810	650	2.50	
		1 315	1 180	<b>875</b>	700	<b>2.80</b>	
6 PR	103 A6 (96 A8)	880	790	585	470	1.50	
		1 050	945	700	560	2.00	
		1 215	1 095	810	650	2.50	
		1 315	1 180	<b>875</b>	700	<b>2.80</b>	

## Tractor Front Tyres (continued)

### Technical data and load capacities

Tyre size	Tread pattern	Type	Rim (permitted)	Tube	Section width (mm)	Overall diameter (mm)	Loaded static radius (mm)	Rolling circumference (mm)	
7.50-20	TF-05	TT	5.50F×20 (5.00F, 6.00F)	7.50-20	205	915	420	2 690	

\* Basic Inflation Pressure must be increased about 25%.

For Non-standard version, please contact a producer.

These tyres are for normal agricultural use and not for continuous highway service.



Ply rating PR	Service description LI/SS	Tyre load capacity (kg) at speed (km/h)				Tyre pressure (bar)
		10 *	20	30	40	
<b>6 PR</b>	103 A6 (96 A8)	880	790	585	470	1.50
		1 050	945	700	560	2.00
		1 215	1 095	810	650	2.50
		1 315	1 180	<b>875</b>	700	<b>2.80</b>



**B 2**



**B 5**



**B 6**



**B 11**



**B 15**



**V-5501**



**V-5501A**

# Bantam tyres

For light agricultural equipment and hand trucks

Tyre size	Tread pattern	Ply rating PR	Service description LJ/SS	Type	Rim (permitted)	Tube Flap	Section width (mm)	Overall diameter (mm)	Tyre load capacity (kg)	Tyre pressure (bar)	Speed (km/h)
3.50-6	B 15	4 PR	45 A6	TT	2.50×6	4.00-6	96	343	165	3.00	30
3.50-6	B 15 Ribbed	4 PR	49 A6	TT	2.50×6	4.00-6	100	343	185	2.50	30
4.00-6	V-5501	2 PR	42 A6	TT	3.00×6	4.00-6	114	374	150	2.10	30
4.00-6	V-5501	4 PR	54 A6	TT	3.00×6	4.00-6	114	374	212	2.50	30
4.00-6	V-5501	6 PR	63 A6	TT	3.00×6	4.00-6	114	374	272	3.50	30
4.00-6	B 11	6 PR	59 A6	TT	2.50×6	3.50/4.00-6	109	367	243	4.25	30
3.50-8	B 6	2 PR	42 A4	TT	2.50×8	3.50-8	100	393	150	2.00	20
3.50-8	B 11	4 PR	49 A6	TT	2.50×8	3.50/4.00-8	98	400	185	3.00	30
3.50-8	B 15	4 PR	49 A6	TT	2.50×6	3.50/4.00-8	96	388	185	3.00	30
3.50-8	V-5501	2 PR	42 A6	TT	2.50×8	3.50/4.00-8	100	393	150	2.10	30
3.50-8	V-5501	4 PR	48 A6	TT	2.50×8	3.50/4.00-8	100	393	180	2.50	30
16×4	B 2	4 PR	71 A2	TT	2.50A×8	16×4	114	415	345	3.50	10
16×4	B 5	4 PR	71 A2	TT	2.50A×8	16×4	114	415	345	3.50	10
4.00-8	V-5501B	2 PR	45 A6	TT	3.00×8	3.50/4.00-8	112	418	165	2.10	30
4.00-8	V-5501A	4 PR	55 A6	TT	3.00×8	3.50/4.00-8	112	418	218	2.50	30
4.00-8	B 11	4 PR	57 A6	TT	3.00×8	3.50/4.00-8	109	410	230	2.75	30

These tyres are for normal agricultural use and not for continuous highway service.



## Tread pattern marking – United States

Production name	United States Marking
<b>Tractor Radial Tyres</b>	
HC 1000	R-1
HC 2000	R-1W
HC 3000	R-1W
SFT	R-1W
SST	R-1W
AC 65	R-1W
HC 70	R-1W
AC 70 T	R-1W
AC 70 G	R-1
AC 70 H	R-1W
AC 85	R-1W
AC 85 Row Crop	R-1W
AC 90 Row Crop	R-1
<b>TF</b>	
TF-01	F-2
TF-03	F-2
TF-04	F-2
TF-05	F-2
TF-06	F-2
IM-05	F-3
<b>AR</b>	
AR-01	I-3 / HF-2
AR-02	I-3 / HF-2
AR-03	I-3 / HF-2
AR-04	I-3 / HF-2
AR-05	I-3 / HF-2
AGRITERRA 02	I-3 / HF-2
AGRITERRA 03	I-3 / HF-3
<b>Tractor Diagonal Tyres</b>	
<b>TD</b>	
TD-01	R-1
TD-02	R-1
TD-03	R-1
TD-05	R-1
TD-10	R-1

Production name	United States Marking
TD-13	R-1
TD-17	R-1
TD-19	R-1
<b>AF</b>	
AF-01	R-1
TL-01	R-1
<b>IM</b>	
IM-01	I-3
IM-02	I-3
IM-03	I-1
IM-04	I-1
IM-06	I-1
IM-07	I-1
IM-08	I-1
IM-09	I-2
IM-10	I-1
<b>TR</b>	
TR-01	R-1
TR-03	R-4
TR-04	R-4
TR-05	R-4
TR-06	I-3
TR-07	I-3
TR-08	I-3 / HF-2
TR-09	R-4
TR-10	R-4
TR-11	R-4
TR-12	R-4
<b>TS</b>	
TS-01	R-1
TS-02	R-1
TS-03	R-1
TS-04	R-1
TS-05	R-1
TS-06	R-1
TS-07	R-1

# Use and Maintenance

## Storage

- > Keep the tyres clean and away from heat, light, ozone or hydrocarbon sources.
- > Avoid prolonged exposure of the tyres to direct sunlight.
- > Avoid any contact with grease, petrol, volatile solvents or other substances that may deteriorate the rubber.
- > Avoid horizontal storage for tubeless tyres, only small size tyres may be stacked or stored flat (maximum 6 months).
- > When tyres are stored flat (horizontal), the position must be lug against lug.
- > Reduce inflation pressure when tyres are stored fitted on rims.
- > Ensure there is no water or moisture inside the tyre.
- > Never store tyres directly in contact with the ground for long periods.

## Tyre repairs

- > For safety reasons, repairs should only be carried out by specialists using the correct tools.

## Proper use of tyres

- > When loading tyres you have to consider the correlation between speed, inflation pressure and load capacity.
- > Overloading results in premature tyre failure. Use the technical documentation and inflation tables which show the load and pressure figures for different operating speeds.
- > Underinflation results not only in incorrect tread wear but also in ply separation and eventually further damage to the ply.
- > Overinflation makes the tyre stiff and decreases its resistance against hits, leading to ply tear.



Check inflation pressure regularly



Avoid contact with grease, oil and other chemicals



Inspect tyres for damage and irregularities



Observe tyre and vehicle load limits



Read safety and maintenance recommendations



Use only authorised repair

## Fitting and removal instructions

**Demounting and mounting procedures can be dangerous, and should be performed only by trained and qualified staff, using proper tools and procedures. Failure to comply with these procedures may result in faulty positioning of the tyre on the rim, and cause the tyre to burst with explosive force leading to serious physical injury or death.**

### Fitting

1. Make sure that the rim, the tyre and the tube are compatible.
2. Check that the tyre is suitable for the machine. Use only rims recommended or permitted by the tyre manufacturer.
3. Always use the proper specialised equipment and tools.
4. The rim must be clean and in perfect condition (no damage, etc.). If necessary, clean the rim thoroughly with a wire brush. Never fit a tyre onto a rim that shows cracks, significant distortion, evidence of welded repair, etc.
5. Thoroughly inspect the inside as well as the outside of the tyre in order to identify any damage which may be present. If the damage is considered to be beyond repair, the tyre should be scrapped.
6. If fitting with a tube, always use the correct new tube and flap for the tyre size. For fitting tubeless tyres without tubes, on tubeless rims, always use a new tubeless valve.
7. Before fitting, lubricate the rim and the beads. Use only a suitable lubricant that will not damage the tyre (never use silicone or petroleum-based products).
8. We recommend vertical fitting. In case of horizontal fitting it is impossible to see if the lower bead is correctly seated.
9. Fit the tyre on the rim diametrically opposite to the valve hole (respect, if present, the rotation direction indicated by the arrows). With the help of a suitable lever and closely repeated applications, get the first bead over the rim flange. Then pose the lightly inflated talc coated tube (if fitted) inside the tyre. Locate the valve, fitting the ferrule loosely. Fit the second bead, lever it progressively over the rim flange, finish at the valve.
10. For seating the beads and centring of the tyre, remove the valve core. Slowly inflate to ensure correct seating of the beads. Ensure that the beads do not pinch the tube.
11. During tyre inflation keep at a safe distance and always use a safety cage. If possible, fasten the tyre to the wall or use retaining chains. During pressure readings ensure that no part of the body is within the possible trajectory of the valve mechanism or of the caps. It is recommended to use suitable pressure limitation gauges. Use a filter and dehumidifier on the compressed air line to avoid introducing humidity or dirt. Never use a hammer to make a tyre bead seat by hitting it.
12. Continue inflation. Make sure that you do not inflate beyond 2.5 bar if the beads are not well seated and centred on the wheel.
13. If the beads are not correctly seated, deflate, lubricate and inflate again. Repeat these operations until the beads are correctly seated.
14. When all the previous operations have been correctly done refit the valve core. Set the pressure according to the load – see tables in technical databook.
15. Make sure the valves do not touch the rims, the brake drums or other fixed mechanical parts.

### Removing

- > Never try to unseat the beads of an inflated tyre.
- > Always remove the valve core.
- > Let the tyre deflate, check before unseating that the tyre is completely deflated. Never use tools that could damage the rims or the beads of the tyre.



# Liquid ballasting of tractor tyres

In some cases, it is necessary to add weight to tyres to increase traction power. Filling the tyre with a liquid (water) is a simple and inexpensive way. It is possible to add liquid to the tyres up to 75% of their volume. In winter, to avoid the water damaging the tyres when it freezes, suitable quantities of anti-freeze must be added.

## Instructions for adding liquid

1. Jack the wheel up and position the valve at the highest vertical point.
2. Unscrew the removable valve body from the valve and connect a combined air-water fill and draining valve to the valve chunk. Air can be removed from the tyre through this valve while the water is entering.
3. Introduce the water or anti-freeze mixture into the tyre. Stop filling when liquid starts to issue from the valve. The quantity of liquid added will be about 75%. Do not over-fill!
4. Replace the valve body and inflate the tyre to the recommended operating pressure.
5. Clean all metal parts – anti-freeze solution is corrosive.

## Instructions for draining liquid

1. Jack the wheel up and position the valve at the lowest vertical point.
2. Unscrew the valve core and let the water drain out.
3. Attach a small rubber hose of suitable length to the locking washer and insert the hose into the tyre tube, then screw the washer down over the stem of the valve.
4. Inflate the tyre with air.
5. Remove the internal valve stem and let the remaining water drain from the tyre.
6. Remove the rubber hose and reassemble the valve. Inflate with air up to the recommended pressure.

## Anti-freeze solution

- > As protection against frost, it is recommended to add Calcium Chloride ( $\text{CaCl}_2$ ). If a tubeless tyre is mounted, we recommend that the rim should be treated against corrosion or an inner tube must be used.
- > Remember – prepare the solution by pouring the Calcium Chloride into the water, stirring to help it dissolve. Never pour water on to Calcium Chloride, it is dangerous.

$\text{CaCl}_2$ per litre of water	Protection to
200 g	-10 °C
250 g	-15 °C
300 g	-20 °C
350 g	-25 °C
400 g	-30 °C

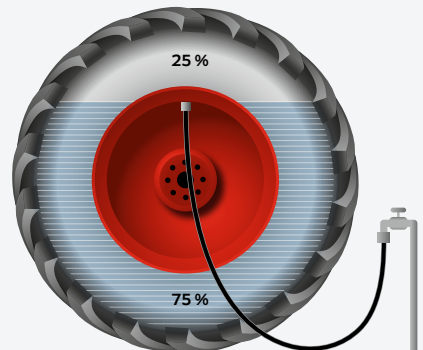

# Liquid ballasting of tractor tyres

Quantity when approx. 75 % full

Inch	Tyre size (Alternative Tyre size)	Tread pattern	Liquid (l)
16"	200/70 R 16	AC 70 T	35
	240/70 R 16	AC 70 T	40
	260/70 R 16	AC 70 T	45
	265/70 R 16 MPT	AC 70 G	45
	280/70 R 16	AC 70 T	50
	285/80 R 16 MPT	AC 70 G	60
	320/65 R 16	AC 65	65
17"	425/55 R 17 MPT	AC 70 G	95
18"	280/70 R 18	AC 70 T	55
	325/70 R 18 MPT	AC 70 G	82
	365/70 R 18 MPT	AC 70 G	105
20"	260/70 R 20	AC 70 T	52
	275/80 R 20 MPT	AC 70 G	65
	280/70 R 20	AC 70 T	60
	280/85 R 20 (11.2 R 20)	AC 85	65
	300/70 R 20	AC 70 T	70
	320/70 R 20	AC 70 T	80
	335/80 R 20 MPT	AC 70 G	105
	360/70 R 20	AC 70 T	115
	375/70 R 20 MPT	AC 70 G	120
	380/70 R 20	AC 70 T	120
	405/70 R 20 MPT	AC 70 G	140
	420/65 R 20	AC 65	145
	425/75 R 20 MPT	AC 70 G	150
	22.5"	445/65 R 22.5 MPT	AC 70 +
24"	280/85 R 24 (11.2 R 24)	AC 85	85
	320/70 R 24	HC 70	100
	320/70 R 24	AC 70 T	100
	320/85 R 24 (12.4 R 24)	AC 85	115
	340/85 R 24 (13.6 R 24)	AC 85	140
	360/70 R 24	HC 70	125
	360/70 R 24	AC 70 T	125
	380/70 R 24	HC 70	145
	380/70 R 24	AC 70 T	145

Inch	Tyre size (Alternative Tyre size)	Tread pattern	Liquid (l)
20"	380/70 R 24	AC 70 G	145
	380/85 R 24 (14.9 R 24)	AC 85	185
	405/70 R 24 MPT	AC 70 G	155
	420/70 R 24	HC 70	170
	420/70 R 24	AC 70 T	170
	420/70 R 24	AC 70 G	170
	420/85 R 24 (16.9 R 24)	AC 85	240
	440/65 R 24	AC 65	185
	440/80 R 24 IND	HCM	230
	445/70 R 24 MPT	AC 70 G	205
	460/70 R 24 IMP	AC 70 G	220
	480/65 R 24	AC 65	210
	480/70 R 24	HC 70	225
	480/70 R 24	AC 70 G	225
	495/70 R 24 MPT	AC 70 G	240
	500/70 R 24 IMP	AC 70 G	245
	500/85 R 24 IMP	SFT	310
	540/65 R 24	AC 65	300
	25"	1000/50 R 25	SFT
26"	620/75 R 26	SFT	505
	750/65 R 26	SFT	600
28"	280/85 R 28 (11.2 R 28)	AC 85	100
	320/85 R 28 (12.4 R 28)	AC 85	130
	340/85 R 28 (13.6 R 28)	AC 85	160
	380/70 R 28	HC 70	165
	380/70 R 28	AC 70 T	165
	380/85 R 28 (14.9 R 28)	AC 85	205
	400/80 R 28 IND	HCM	205
	420/70 R 28	HC 70	200
	420/70 R 28	AC 70 T	200
	420/70 R 28	AC 70 G	200
	VF 420/85 R 28 (16.9 R 28)	HC 2000	250
420/85 R 28 (16.9 R 28)	AC 85	250	
440/65 R 28	AC 65	200	

Inch	Tyre size (Alternative Tyre size)	Tread pattern	Liquid (l)	
	440/70 R 28 IND	AC 70 G	215	
	440/80 R 28 IND	HCM	255	
	480/65 R 28	AC 65	250	
	480/70 R 28	HC 70	260	
	480/70 R 28	AC 70 T	260	
	500/80 R 28 IMP	SFT	350	
	540/65 R 28	SFT	315	
	540/65 R 28	AC 65	315	
	600/65 R 28	SFT	400	
	600/65 R 28	AC 65	400	
	600/65 R 28 IMP	AC 65	400	
	600/70 R 28	SFT	490	
	30"	380/85 R 30 (14.9 R 30)	AC 85	220
		420/70 R 30	HC 70	225
420/70 R 30		AC 70 T	225	
420/85 R 30 (16.9 R 30)		AC 85	270	
420/90 R 30		AC 85	285	
460/85 R 30 (18.4 R 30)		AC 85	340	
480/70 R 30		HC 70	275	
480/70 R 30		AC 70 T	275	
480/70 R 30		AC 70 G	275	
500/85 R 30 IMP		SFT	390	
VF 600/70 R 30		HC 2000	490	
540/65 R 30		SFT	330	
540/65 R 30		AC 65	330	
540/65 R 30 IMP		AC 65	330	
600/65 R 30		AC 65	430	
VF 600/70 R 30		HC 2000	490	
600/70 R 30		SFT	490	
620/70 R 30 IMP		SFT	495	
620/70 R 30 IMP		SFT N	495	
620/75 R 30		SFT	550	
620/75 R 30 IMP	SFT	550		
710/55 R 30	SFT	520		

Inch	Tyre size (Alternative Tyre size)	Tread pattern	Liquid (l)
	710/60 R 30	SFT	550
	710/60 R 30 IMP	SFT	550
	710/65 R 30 IMP	SFT	630
	750/55 R 30	SFT	500
32"	270/80 R 32	AC 90	100
	270/95 R 32	AC 85	115
	320/85 R 32 (12.4 R 32)	AC 85	140
	320/90 R 32	AC 85	150
	650/75 R 32	AC 70 N	700
	650/75 R 32	AC 75 G	700
	650/75 R 32	AC 70 G	700
	680/85 R 32 CHO	AC 70 G	950
	680/85 R 32	AC 70 G	950
	800/65 R 32	AC 70 H	900
	800/65 R 32	AC 70 N	900
	800/70 R 32 CHO	SFT	1000
	800/70 R 32	SFT	1000
	900/60 R 32 CHO	SFT	1030
900/60 R 32	SFT	1030	
900/70 R 32 CHO	SFT	1200	
900/70 R 32	SFT	1200	
1050/50 R 32	SFT	1280	
1250/50 R 32	SFT	1500	
34"	320/85 R 34	AC 85	205
	VF 380/85 R 34 (14.9 R 34)	HC 2000	240
	380/85 R 34 (14.9 R 34)	AC 85	240
	420/85 R 34 (16.9 R 34)	AC 85	290
	460/85 R 34 (18.4 R 34)	AC 85	380
	480/70 R 34	HC 70	310
	480/70 R 34	AC 70 T	310
	480/70 R 34	AC 70 G	310
	500/85 R 34 IMP	SFT	445
	520/70 R 34	HC 70	335
	520/70 R 34	AC 70 T	335

## Liquid ballasting of tractor tyres (continued)

Quantity when approx. 75 % full

Inch	Tyre size (Alternative Tyre size)	Tread pattern	Liquid (l)
	520/70 R 34	AC 70 G	335
	540/65 R 34	AC 65	360
	600/65 R 34	AC 65	465
	650/60 R 34	SFT	540
	650/65 R 34	SFT	600
	710/60 R 34	SFT	660
36"	270/80 R 36	AC 90	115
38"	320/85 R 38 (12.4 R 38)	AC 85	205
	340/85 R 38 (13.6 R 38)	AC 85	215
	380/80 R 38 (14.9 R 38)	AC 85	240
	VF 380/95 R 38	HC 2000	280
	380/95 R 38	AC 85	280
	420/85 R 38 (16.9 R 38)	AC 85	320
	460/85 R 38 (18.4 R 38)	AC 85	420
	480/70 R 38	HC 70	340
	480/70 R 38	AC 70 T	340
	480/80 R 38 IND	HCM	385
	520/70 R 38	HC 70	395
	520/70 R 38	AC 70 T	395
	520/70 R 38	AC 70 G	395
	520/85 R 38 (20.8 R 38)	AC 85	530
	540/65 R 38	AC 65	420
	540/80 R 38 IND	HCM	505
	580/70 R 38	HC 70	550
	580/70 R 38	AC 70 T	550
	600/65 R 38	SST	500
	600/65 R 38	AC 65	500
	650/65 R 38	SFT	630
	650/65 R 38	SST	630
	650/65 R 38	AC 65	630
	650/75 R 38	SFT	750
	650/85 R 38	SFT	900
	680/80 R 38 CHO	SFT	865
	710/70 R 38	SFT	800

Inch	Tyre size (Alternative Tyre size)	Tread pattern	Liquid (l)
	710/70 R 38	AC 65	800
	800/70 R 38 CHO	SFT	1100
	800/70 R 38	SFT	1100
	900/60 R 38 CHO	SFT	1200
	900/60 R 38	SFT	1200
42"	300/85 R 42 (11.2 R 42)	AC 90	140
	300/95 R 42 (12.4 R 42)	AC 90	185
	480/80 R 42	AC 85	460
	VF 520/85 R 42	HC 2000	580
	VF 520/85 R 42 CFO	HC 3000	580
	520/85 R 42 (20.8 R 42)	AC 85	580
	VF 580/85 R 42 CFO	HC 3000	645
	580/85 R 42	SFT	645
	VF 650/65 R 42	HC 2000	650
	650/65 R 42	SST	650
	650/65 R 42	AC 65	650
	650/75 R 42	SFT	740
	680/80 R 42 CHO	SFT	1020
	680/80 R 42	SFT	1020
	VF 710/70 R 42	HC 2000	880
	VF 710/70 R 42 CFO	HC 3000	880
	710/70 R 42	SFT	880
	710/75 R 42	SFT	950
	800/70 R 42 CHO	SFT	1135
	900/60 R 42	SFT	1320
	900/60 R 42 CHO	SFT	1320
46"	320/95 R 46	AC 85	215
	VF 380/90 R 46	HC 1000	330
	380/90 R 46	AC 85	330
	VF 480/80 R 46	HC 2000	500
	480/80 R 46	AC 85	500
	520/85 R 46 (20.8 R 46)	AC 85	620
	710/65 R 46	SFT	925
	IF 710/65 R 46	SFT	925

Inch	Tyre size (Alternative Tyre size)	Tread pattern	Liquid (l)
48"	270/95 R 48	AC 90	150
	340/90 R 48 (13.6 R 48)	AC 85	230
50"	320/90 R 50	AC 85	245
	380/90 R 50	AC 85	360
	VF 380/105 R 50	HC 1000	395
	480/80 R 50	AC 85	550
	VF 480/95 R 50	HC 2000	650
	480/95 R 50	AC 85	650
	54"	320/90 R 54	AC 85
380/90 R 54		AC 85	345
VF 380/105 R 54		HC 2000	414
380/105 R 54		AC 85	414

Tyre size Diagonal tyres	Liquid (l)
8.3 - 20	45
8.3 - 24	50
9.5 - 24	60
11.2 - 24	70
12.4 - 24	80
13.6 - 24	120
14.9 - 24	150
16.9 - 24	210
18.4 - 26	305
23.1 - 26	470
11.2 - 28	90
12.4 - 28	110
13.6 - 28	140
14.9 - 28	180
16.9 - 28	220
16.9 - 30	240
18.4 - 30	320
9.5 - 32	80
12.4 - 32	140
16.9 - 34	250
18.4 - 34	330
12.4 - 36	150
12.4 - 38	170
13.6 - 38	190
14.9 - 38	220
15.5 - 38	245
16.9 - 38	280
18.4 - 38	370

## Explanations referring to tractor tyres

Tables on page 22 to 103, 152 to 167 and 194 to 203

### Load capacity and speed

When determining the minimum tyre size necessary for a vehicle, the approved axle load and the maximum design speed of the vehicle should always be used as the basis.

Nominal load capacity = 100 % load, as indicated by the Load Index (LI), see page 13.

In the case of twin-fitted driven wheels, a factor of 1.76 is applied to the load capacity of a single-fitted tyre.

### Tyre pressure

The tyre pressures given in the tables are minimum tyre pressures and should be used as a guide only.

The given max. air pressures may not be exceeded. All tyre pressures refer to the "cold" tyre which has been standing outdoors for several hours, not exposed to intense sunlight.

For twin fitments of radial tyres on tractors (to minimise ground pressure) a min. tyre pressure of 0.4 bar is allowed.

The Static Loaded Radius is the distance between centre of wheel and paved ground measured at reference load and pressure.

The Rolling Circumference (at reference load and reference pressure) is the distance a tyre covers with one revolution on paved surface. Measurement acc. to ISO 11795.

The Speed Radius Index (SRI) is by convention a parameter used exclusively for calculation of theoretical speed of tractors. In no case SRI can be used as measurable value of rolling circumference.

Instead of W or W...L rims, the same size in DW or DWW may be used if the flange height is the same. (Designation of rims see pages 198.)

Old	Temporary	New	In millimetres
8	8.3/8	8.3	
9	9.5/9	9.5	240
10	11.2/10	11.2	280
11	12.4/11	12.4	320
12	13.6/12	13.6	340
13	14.9/13	14.9	380

Old	Temporary	New	In millimetres
14	16.9/14	16.9	420
15	18.4/15	18.4	460
16	20.8/16	20.8	520
18	23.1/18	23.1	
<b>Sample</b>			
13-28	14.9/13-28	14.9-28	380/85-28

# Variation in load capacity with speed dependence

## Tractor Radial & Diagonal

Speed (km/h)	0	5	10	15	20	25	30	35
Speed Category A6	+130%	+70%	+40%	+30%	+20%	+7%	(0)	-10%
A8	+130%	+70%	+50%	+34%	+23%	+11%	+7%	+3%
D	+130%	+70%	+40%	+34%	+23%	+18.5%	+15%	+12%

Speed (km/h)	40	45	50	55	60	65	70
Speed Category A6	-20%	-	-	-	-	-	-
A8	(0)	-4%	-9%	-	-	-	-
D	+9.5%	+7%	+5%	+3%	+1.5%	(0)	-9%

All Field Applications:

A6 Tyres – loads as in the Table

A8 Tyres – loads as in the Table plus 7%

The Inflation Pressure must be increased for:

- road transport and long-distance transport with semi-trailer +0.3 bar
- harvesting machines and front-end loader tractor application +0.4 bar

## Tractor Front – Steering Wheels

Speed (km/h)	10 *	15	20	25	30	35	40	45
Speed Category A6	+50%	+43%	+35%	+15%	(0)	-10%	-20%	
A8	+67%	+50%	+39%	+28%	+11%	+4%	(0)	-7%

\* Basic Inflation Pressure must be increased about 25%.

If a front-end loader is fitted on the tractor, +100% applies.

## Explanations referring to IMP/MPT tyres

Tables on page 104 to 125 and 168 to 193

IMP = Implement tyres

MPT = Multi purpose tyres

### Load capacity and speed

When determining the minimum tyre size necessary for a vehicle, the approved axle load and the maximum design speed of the vehicle should always be used as the basis.

Nominal load capacity = 100 % load, as indicated by the Load Index (LI), see page 13.

### Tyre pressure

The tyre pressures given in the tables are minimum tyre pressures and should be used as a guide only.

The given max. air pressures may not be exceeded.

All tyre pressures refer to a “cold” tyre which has been standing outdoors for several hours, not exposed to intense sunlight.

The static radius is for the new tyre laden at the max. load capacity and at the corresponding tyre pressure as per the table concerned.

The rolling circumference corresponds to the max. load capacity (100%) and is inflated at the corresponding tyre pressure as per the table concerned. At 50% of the max. load capacity the rolling circumference is increased by approx. 1% for a radial tyre and by approx. 1.8% for a cross-ply tyre on the drive wheel of an agricultural tractor.

Rims. Only the rims indicated in this data book are approved for fitting to new vehicle series.

⊙ – drive wheel

⊞ – free rolling wheel



# Variation in load capacity with speed dependence

## AR-01, AR-02

Speed (km/h)		0	5	10	15	20	25	30	35	40
Speed Category	D	+95%	+87%	+75%	+60%	+50%	+40%	+35%	+30%	+24%
	F	+150%	+110%	+80%	+65%	+50%	+35%	+25%	+19%	+15%

Speed (km/h)		45	50	55	60	65	70	75	80
Speed Category	D	+17%	+11%	+7%	+3%	(0)	-	-	-
	F	+13%	+12%	+11%	+10%	+7.5%	+5%	+2.5%	(0)

## Agriterra 02, Agriterra 03

Speed (km/h)		0	5	10	15	20	25	30	35	40
Speed Category	D	+130%	-	+80%	+73%	+65%	+58%	+51%	+44%	+36%

Speed (km/h)		45	50	55	60	65	70	75	80
Speed Category	D	+29%	+21%	+14%	+7%	(0)	-	-	-

## Implement, Implement Traction, Tractor Small – Free rolling

Speed (km/h)		0	10	15	20	25	30	35	40	45	50
A6 (30 km/h)	LLV	+65%	+29%	+21%	+14%	+7%	(0)	-5%	-10%	-	-
	HLV	+98%	+55%	+45%	+37%	+28%	+20%	+14%	+8%	-	-
A8 (40 km/h)	LLV	+65%	+40%	+33%	+26%	+19%	+12%	+5%	(0)	-5%	-10%
	HLV	+98%	+68%	+60%	+51%	+43%	+34%	+26%	+20%	+14%	+8%

## Implement, Implement Traction, Tractor Small – Drive wheels

Speed (km/h)		0	10	15	20	25	30	35	40	45	50
A6 (30 km/h)	LLV	+135%	+29%	+21%	+14%	+7%	(0)	-5%	-10%	-	-
	HLV	+193%	+84%	+73%	+63%	+53%	+43%	+36%	+29%	-	-
A8 (40 km/h)	LLV	+135%	+40%	+33%	+26%	+19%	+12%	+5%	(0)	-5%	-10%
	HLV	+193%	+100%	+90%	+80%	+70%	+60%	+50%	+43%	+36%	+29%

LLV = Low Load Variation

HLV = High Load Variation, is where the tyre load varies by a factor of "2" or more between loaded and unloaded conditions.

The inflation pressure for HLV application must be increased, consult tyre manufacturer.

In the case of HLV, the maximum distance should not exceed 1 km. For a longer distance, consult tyre manufacturer.

# Rim specification

## Sample of rim marking

DW18L x 38	Meaning
DW	Rim Contour
18	Nominal Rim Width in inches
L	Flange Height code
x	One-piece rim
38	Nominal Rim Diameter in inches

## Sample of rim marking

	Meaning
W	Wide Drop Centre – Single Well shape rim
DW	Wide Drop Centre – Double Well shape rim
SDC	Semi-drop Centre rim
-	Multi-piece rim
x	One-piece rim
H2	Double Hump
DC	Drop Centre rim

Nominal	D	Nominal	D
16"	405.6	34"	868.4
18"	462.0	36"	919.2
20"	512.8	38"	970.0
24"	614.4	42"	1 071.6
26"	665.2	46"	1 173.2
28"	716.0	48"	1 224.0
30"	766.8	50"	1 274.8
32"	817.6	54"	1 376.4

## W and DW rims

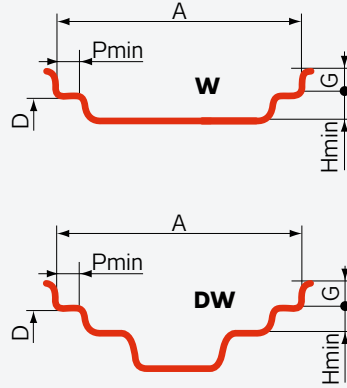

Rim	A	G	P min.	H min.
W6	152.5	22.5	23.5	20.5
W7	178.0	22.5	23.5	20.5
W8	203.0	22.5	23.5	20.5
W9	228.5	25.5	27.0	20.5
W10	254.0	25.5	27.0	20.5
W11	279.5	25.5	27.0	20.5
W12	305.0	25.5	27.0	20.5
W13	330.0	25.5	27.0	20.5
W8L	203.0	22.5	27.0	20.5
W14L	355.5	25.5	27.0	20.5
W15L	381.0	25.5	33.0	20.5
W16L	406.5	25.5	33.0	20.5
W18L	457.0	25.5	33.0	20.5
DW16L	406.5	25.5	50.5	27.0
DW18L	457.0	25.5	50.5	27.0
DW20B	508.0	29.0	50.5	27.0
DW21B	533.5	29.0	50.5	27.0
DW23B	584.0	29.0	50.5	27.0

## 5° Drop-centre rims

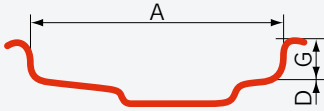

Rim	A	G	D
3.00Bx10	76.0	14.1	253.2
3.50Bx10	89.0	14.1	253.2
4Jx10	101.5	17.3	253.2
4Jx15	101.5	17.3	380.2
41/2Kx15	114.5	18.0	380.2
5Jx12	127.0	17.3	304.0
5Jx14	127.0	17.3	354.8
5Jx15	127.0	17.3	380.2

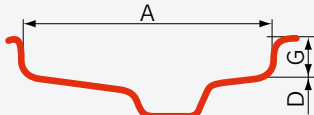

Rim	A	G	D
9x18	228.5	25.5	462.0
9.00x12	228.5	19.0	305.6
9.00x15.3	228.5	19.0	388.8
11x18	279.5	25.5	462.0
12x18	305.0	25.5	462.0
13x17	330.0	25.5	436.6
13.00x17	330.0	19.0	436.6
16.00x17	406.5	19.0	436.6

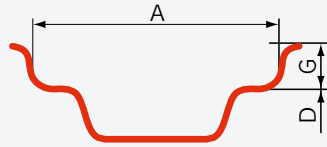

Rim	A	G	D
4.00Ex12	101.5	20.0	304.0
4.00Ex16	101.5	20.0	405.6
4.50Ex16	114.5	20.0	405.6
5.00Fx16	127.0	22.5	405.6
5.00Fx20	127.0	22.5	512.8
5JAx12	127.0	16.0	304.0
5.50Fx16	139.5	22.5	405.6
5.50Fx20	139.5	22.5	512.8
6.00Fx16	152.5	22.5	405.6
6.00Fx20	152.5	22.5	512.8
7.00x12	178.0	20.5	304.0
7.00x15	178.0	20.5	380.2
7.00l-16 **	178.0	16.0	405.6

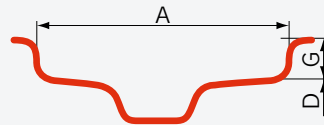

Rim	A	G	D
2.50x8	63.5	14.0	202.4
2.50Ax8	63.5	11.5	202.4
3.00Dx8	76.0	17.5	202.4
3.00Dx10	76.0	18.0	253.2
3.00Dx12	76.0	18.0	304.0
3.00Dx15	76.0	18.0	380.2

## Rim specification (continued)

### 15° Drop-centre rims

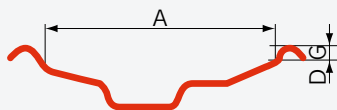

Rim	A	G	D
6.75x14.5	171.5	12.7	368.3
10.50x17.5	266.5	12.7	444.5
11.75x22.5	298.5	12.7	571.5
13.00x15.5	330.0	12.7	393.7
14.00x22.5	355.6	12.7	571.5
16.00x22.5	406.4	12.7	571.5
20.00x22.5	508.0	12.7	571.5
AG20.00x26.5	508.0	12.7	673.1
AG24.00x26.5	609.5	12.7	673.1
AG20.00x30.5	508.0	12.7	774.7

### 5° Semi drop-centre rims

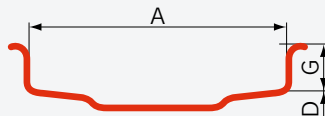

Rim	A	G	D
13x20 SDC	330.0	25.5	512.8



Rim	A	G	D
13LBx15	330.2	11.0	380.2

### 5° Divided rims

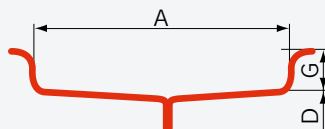

Rim	A	G	D
2.10-4 *	53.5	12.0	100.8

### 5° Tapered rim

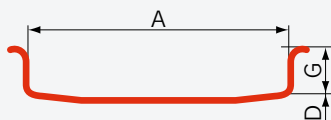

Rim	A	G	D
7.0-401.5	178.0	38.0	401.5

D Specified diameter (mm)

\* divided rim

\*\* multi-piece rim



## Terms and abbreviations used in this catalogue

Acronyms	Meaning	Definition
<b>PR</b>	Ply Rating	Identifies different versions (load capacity/inflation pressure) of tyres having the same size designation.
<b>TYPE</b>	Tubeless or Tube Type	Tubeless (TL) – Tyres specifically designed for fitment without an inner tube on appropriate rims. Tubeless tyres may be used with a tube.
<b>LI</b>	Load Index	Is a numerical code associated with the maximum load a tyre can carry at the speed indicated by its Speed Symbol under service conditions specified by the tyre manufacturer.
<b>SS</b>	Speed Symbol	Indicated the maximum speed at which the tyre can carry a load corresponding to its Load Index under service conditions specified the tyre manufacturer.
	Free Rolling Wheels	Free rolling wheels, that not transmit motion, e.g. trailer
	Drive Wheels	Drive wheels, that transmit motion, e.g. drive wheel axle on tractors
<b>RIM</b>	Recommended Rim	The rim which gives the best fitment of the tyre for all conditions and types of service.
<b>RIM (PERMITTED)</b>	Permitted Rim	Any rim which can be permitted in addition to the recommended rim.
	New Tyre Dimensions	The dimensions of an unloaded new tyre mounted on its Measuring Rim at the recommended inflation pressure and allowed to stand for a minimum of 24 hours at normal room temperature before readjustment of the pressure back to its original level.
	Section Width (design)	The linear distance between the outsides of the sidewalls of an inflated new tyre excluding elevations due to labelling (marking), decorations, or protective bands or ribs.
	Overall Diameter (design)	The diameter of an inflated tyre at the outermost surface of the tread.
	Static Radius (theoretical nominal)	The radius of the new tyre loaded at the maximum load capacity and with the corresponding tyre pressure.
	Rolling Circumference (theoretical nominal)	The circumference of the tyre loaded at the maximum load capacity and with the corresponding tyre pressure.

Acronyms	Meaning	Definition
<b>LOAD CAPACITY</b>	Tyre Load Carrying Capacity	The maximum load (kg) a tyre is permitted to carry under specified operating conditions. In the case of twin-fitted driven wheels, a factor of 1.76 is applied to the load capacity of a single fitment tyre.
	Inflation Pressure	The “cold” pressure (kPa) of the fluid with which the tyre is inflated.
<b>HLV</b>	High Load Variation	Is where the tyre load varies by a factor of “2” or more between loaded and unloaded conditions. The inflation pressure for HLV application must be increased, consult tyre manufacturer. In the case of HLV, the maximum distance should not exceed 1 km and maximum speed 10 km/h. For a longer distance or higher speed, consult tyre manufacturer. Example of purpose: without HLV – normal use with constant load in transport service, on tractor in field service, e.g. trailer, tractor; with HLV – use with various load conditions, factor > 2 between loaded and unloaded, e.g. loaders
<b>LLV</b>	Low Load Variation	Standard application with low load difference between loaded and unloaded conditions.
<b>WATER 75%</b>	Capacity of Water	Capacity of water for Water balasting.
<b>ETRTO</b>	The European Tyre and Rim Technical Organisation	Data in this Technical Databook are relevant with ETRTO standards, the further data you can find there.
<b>SRI</b>	Speed Radius Index	The Speed Radius Index is by convention a parameter used exclusively for the calculation of the theoretical speed of tractors during European Union homologation procedures and for interchangeability of different tyre sizes.
	Nominal Section Width	The section width of an inflated tyre mounted on its theoretical rim and indicated in the tyre size designation.
<b>IND</b>		Agricultural tyres for traction wheels for construction applications with load capacities and inflation pressures which differ from those for tyres which the same size designation for use on agricultural tractors.
<b>REINFORCED</b>		Tyres with better protection against tyre damage (puncture). The load capacity and tyre dimensions stay like standard execution.

**MITAS a.s.**

Švehlova 1900/3, 106 00 Prague 10, Czech Republic



MITAS a.s. is fully compliant with the limits on Polycyclic Aromatic Hydrocarbons (PAHs) determined by the European Directive EC/2005/69 and REACH Regulation EC/1907/2006, since December 1st 2009.

**Your Distributor/Dealer:**

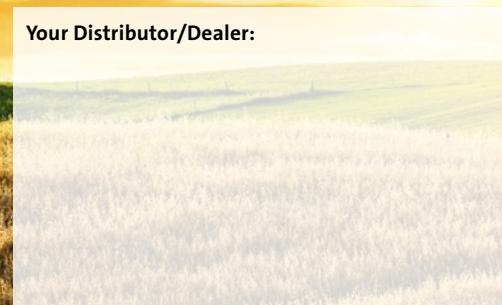

**Mitas**

[mitas-tyres.com](http://mitas-tyres.com)